

JVC

SERVICE MANUAL

REMOTE CONTROL INTEGRATED AMPLIFIER

AX-R561TN AX-R562BK

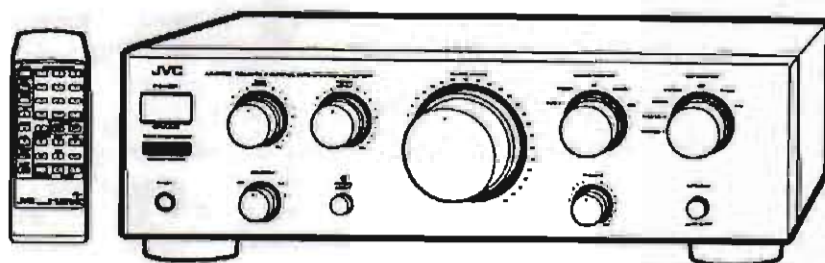

COMPU LINK
Remote
Control Component

Note

These models are completely the same in their structure, except for their outlook colour.

	Page		Page
Safety Precautions	1- 2	Disassembly Procedures	1-22
Instruction Book	1- 3	Power Amplifier Adjustment Procedures	1-23
Description of Major ICs	1-18	Block Diagram	1-24
Internal Block Diagram of Other ICs	1-20	Schematic Diagrams	Insertion
Remote Control Unit	1-21	Printed Circuit Board	Insertion
		Parts List	Separate-volume Insertion

Safety Precautions

1. The design of this product contains special hardware and many circuits and components specially for safety purposes. For continued protection, no changes should be made to the original design unless authorized in writing by the manufacturer. Replacement parts must be identical to those used in the original circuits. Services should be performed by qualified personnel only.
2. Alterations of the design or circuitry of the product should not be made. Any design alterations of the product should not be made. Any design alterations or additions will void the manufacturer's warranty and will further relieve the manufacture of responsibility for personal injury or property damage resulting therefrom.
3. Many electrical and mechanical parts in the products have special safety-related characteristics. These characteristics are often not evident from visual inspection nor can the protection afforded by them necessarily be obtained by using replacement components rated for higher voltage, wattage, etc. Replacement parts which have these special safety characteristics are identified in the Parts List of Service Manual. Electrical components having such features are identified by shading on the schematics and by (Δ) on the Parts List in the Service Manual. The use of a substitute replacement which does not have the same safety characteristics as the recommended replacement parts shown in the Parts List of Service Manual may create shock, fire, or other hazards.
4. The leads in the products are routed and dressed with ties, clamps, tubings, barriers and the like to be separated from live parts, high temperature parts, moving parts and/or sharp edges for the prevention of electric shock and fire hazard. When service is required, the original lead routing and dress should be observed, and it should be confirmed that they have been returned to normal, after re-assembling.

5. Leakage current check (Electrical shock hazard testing)

After re-assembling the product, always perform an isolation check on the exposed metal parts of the product (antenna terminals, knobs, metal cabinet, screw heads, headphone jack, control shafts, etc.) to be sure the product is safe to operate without danger of electrical shock.

Do not use a line isolation transformer during this check.

- Plug the AC line cord directly into the AC outlet. Using a "Leakage Current Tester", measure the leakage current from each exposed metal parts of the cabinet, particularly any exposed metal part having a return path to the chassis, to a known good earth ground. Any leakage current must not exceed 0.5mA AC (r.m.s.).

● Alternate check method

Plug the AC line cord directly into the AC outlet. Use an AC voltmeter having, 1,000 ohms per volt or more sensitivity in the following manner. Connect a 1,500 Ω 10 W resistor paralleled by a 0.15 μ F AC-type capacitor between an exposed metal part and a known good earth ground.

Measure the AC voltage across the resistor with the AC voltmeter.

Move the resistor connection to each exposed metal part, particularly any exposed metal part having a return path to the chassis, and measure the AC voltage across the resistor.

Now, reverse the plug in the AC outlet and repeat each measurement. Any voltage measured must not exceed 0.75 V AC (r.m.s.). This corresponds to 0.5 mA AC (r.m.s.).

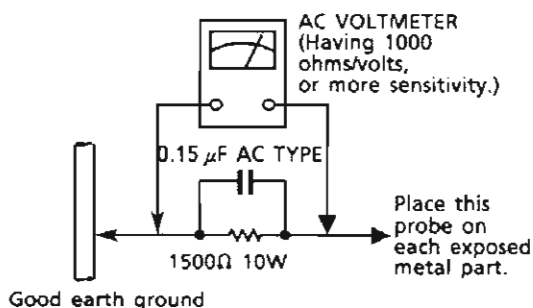

Warning

1. This equipment has been designed and manufactured to meet international safety standards.
2. It is the legal responsibility of the repairer to ensure that these safety standards are maintained.
3. Repairs must be made in accordance with the relevant safety standards.
4. It is essential that safety critical components are replaced by approved parts.
5. If mains voltage selector is provided, check setting for local voltage.

Instruction Book

Introduction

Thank you for purchasing this JVC AX-R561TN/AX-R562BK Amplifier. We hope it will be a valued addition to your audio/visual system. Be sure to read these instructions carefully before operating the amplifier.

About This Manual

This manual gives you the basic information you need to set up and use your amplifier. It explains everything you need to know from turning on the power switch to basic troubleshooting. Please consult your JVC dealer if you have any questions about the amplifier.

Use the following guideline to help you follow the instructions in this manual:

- The switches and controls that you will be using are indicated with capital letters, like this: MASTER VOLUME control
- Connection points on the back of the amplifier are indicated with capital letters, like this: CD jacks
- Parts of this manual must be observed to avoid electric shock or other injury to yourself. These parts are labeled **⚠CAUTION!**
- Steps that you need to follow to get the correct results are labeled *Important!*
- Additional information that is helpful to know, is labeled *Note:*

Before Installing Your Amplifier

Locating the Amplifier

Install the amplifier in a place that is level and protected from moisture.

The temperature around the amplifier must be between -5° and 40° Celsius (23° and 104° Fahrenheit).

Make sure there is good ventilation around the amplifier. Poor ventilation could cause overheating and damage the amplifier.

Making Power Connections

Do not handle the power cord with wet hand.

Do not pull on the power cord to unplug the amplifier. Always pull the molded plug at the end of the cord instead.

Handling the Amplifier

Do not insert any metallic object into the amplifier.

⚠CAUTION! To reduce risks, such as electric shocks or fires:

1. Do not remove screws, covers, or cabinet.
2. Do not expose this appliance to rain or moisture.

Names of Parts

This chapter deals with the names of the switches and controls used for the operation. Page Nos. following the names indicate where the detailed description is given.

Main Unit of the Amplifier

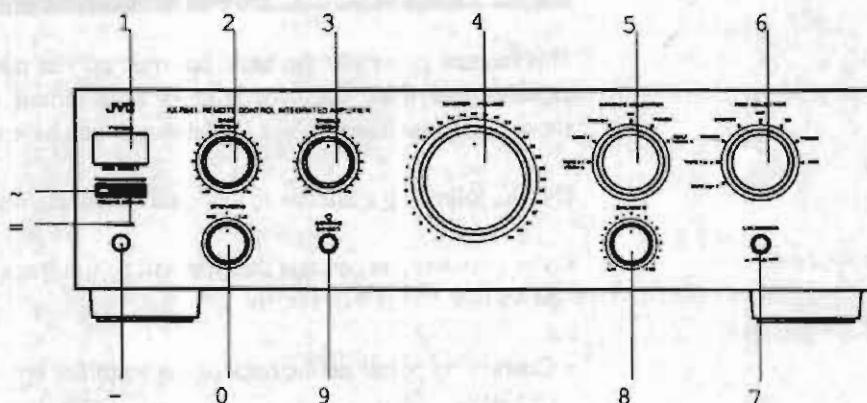

- | | |
|-----------------------------------|------------------------------------|
| 1 POWER switch (page 8) | 8 BALANCE control (page 10) |
| 2 BASS control (page 11) | 9 SOURCE DIRECT switch (page 11) |
| 3 TREBLE control (page 11) | 0 SPEAKERS switch (page 10) |
| 4 MASTER VOLUME control (page 10) | - PHONES jack |
| 5 SOURCE SELECTOR switch (page 9) | = REMOTE SENSOR window |
| 6 REC SELECTOR switch (page 9) | ~ POWER STANDBY/RECEIVED indicator |
| 7 LOUDNESS switch (page 11) | |

Remote Controller

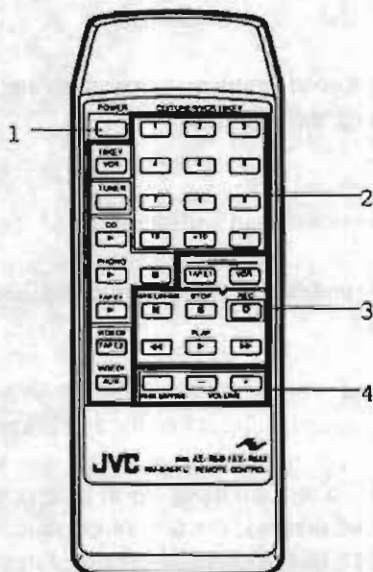

- | |
|-------------------------------------|
| 1 POWER switch (page 8) |
| 2 Simple operation unit (page 13) |
| 3 Extended operation unit (page 14) |
| 4 Volume adjuster (page 10) |

Preparation

This chapter deals with preparatory operations such as connecting the amplifier to other stereo equipment or speakers before use.

Connecting Stereo Equipment

Before Starting

The left channel of any stereo equipment must be connected to the left-channel jack of the amplifier, and the right channel to the right-channel jack. If they are reversed, the correct stereophonic image will not be generated.

Note: To ensure correct connections, insert the red plug into the red jack. (Red, by convention represents the right channel.)

Basic Connections

Connect stereo equipment to the amplifier using cables with RCA PIN plugs. Connect the output jacks on a tape deck to the jacks marked IN (PLAY) on the amplifier, and the input jacks to those marked OUT (REC).

Notes:

- Use the AUX/VIDEO 1 jacks to connect a TV receiver with audio output jacks or a stereo equipment other than those detailed below. A turntable, however cannot be connected to the AUX jacks.
- Connect a ground cable, if fitted to your turntable, to the screw marked GND on the rear panel.
- Any turntables incorporating a small-output cartridge such as an MC (moving-coil type) must be connected to this amplifier through a commercial head amplifier or step-up transformer. Direct connection may result in insufficient volume.

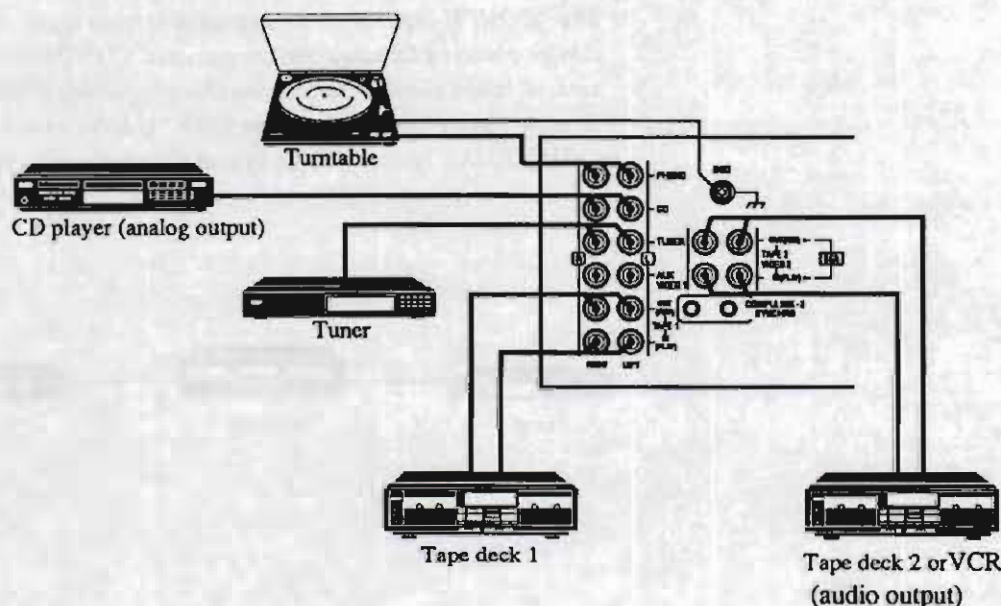

Connecting a Graphic Equalizer

Instead of connecting a second tape deck, you can use a graphic equalizer. Connect the output jack of the graphic equalizer to the TAPE 2/VIDEO 2 jacks marked IN (PLAY), and the input jacks to the TAPE 2/VIDEO 2 jacks marked OUT (REC). JVC's S.E.A. graphic equalizer is recommended.

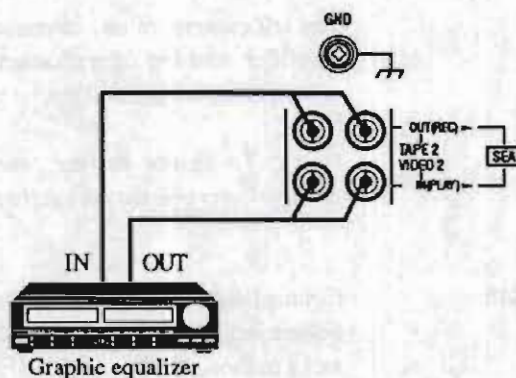

Using the COMPU LINK-3 SYNCHRO Jacks

COMPU LINK-3 SYNCHRO jacks on the back of the amplifier are provided for the COMPU LINK remote control system which interlocks each item of JVC audio equipment with another so that sounds can be heard or recorded easily. To avail oneself of this system's functions, make a connection between the COMPU LINK-3 SYNCHRO jacks of each equipment using the connection cables attached to the JVC source equipment.

Notes:

- The "COMPU LINK-3" is an upgraded version of the "COMPU LINK-1". Similar results can be obtained by using the conventional COMPU LINK-1 SYNCHRO jacks as connectors, although slight imperfections (Simple playing of CD's) may be apparent.
- Refer to page 12 for details of the COMPU LINK remote control system.
- COMPU LINK remote control system does not work on the Tape deck 2.

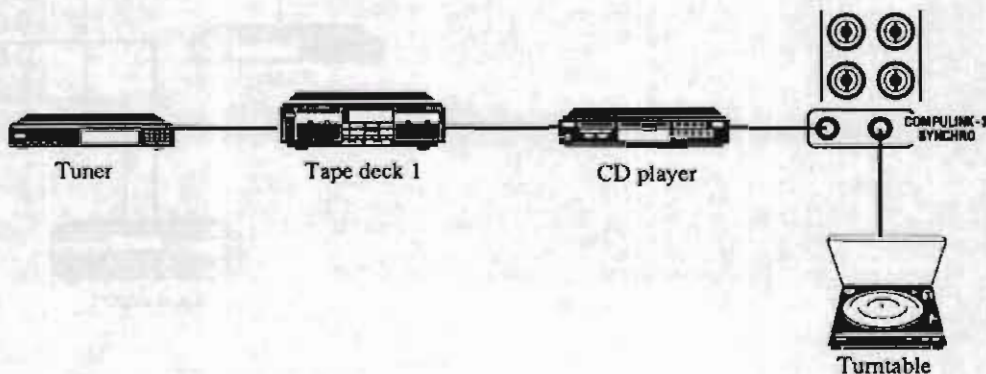

Connecting Speakers

Before starting

Up to two sets of speakers (four speakers in total) can be connected to the amplifier.

Note: Special care is needed in selecting the impedance of the speakers. Only speakers with an impedance of 4 to 16 ohms can be used with this amplifier. However, if two sets of speakers are used at the same time, do not use speakers with an impedance lower than 8 ohms.

Connecting speakers

Rotate the screw counterclockwise to loosen the speaker terminals, and insert the speaker wire as shown on the left. Tighten the screw clockwise to fasten the speaker wire.

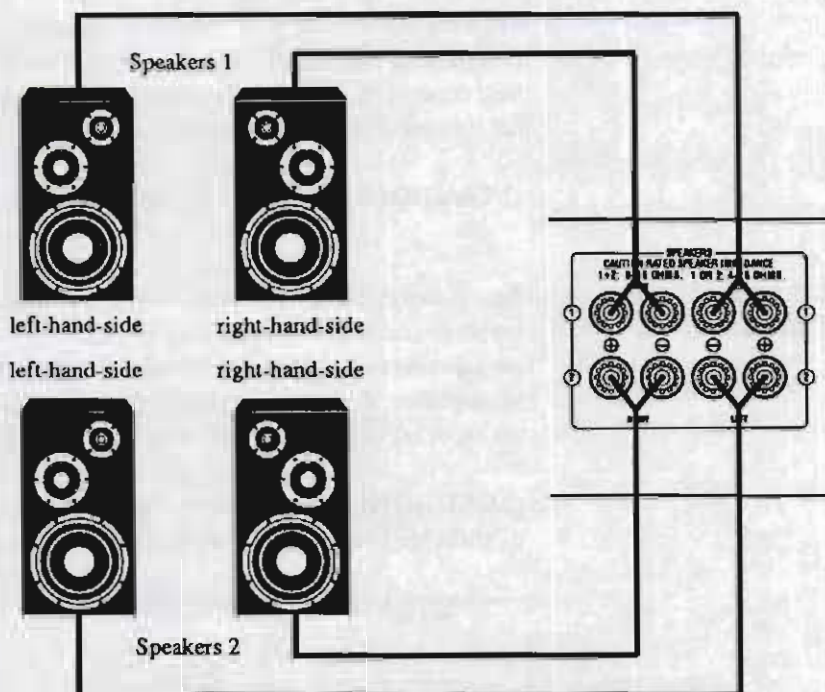
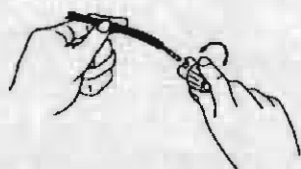

Connecting the Power Supply

Before starting



Check the back of the amplifier for any switches as illustrated on the left.

Amplifiers with a voltage selector switch are available according to the region. This voltage selector switch is used to adjust the amplifier power requirements so as to meet the voltage required in the region where the amplifier is to be used. Turn the switch using a Philips screwdriver and set it so that the arrowhead in "LINE ↓ VOLTS" indicates the supply voltage. Bear in mind incorrect setting may cause malfunction or damage.

⚠ CAUTION! Be sure to set the voltage selector switch before connecting the power supply.

Connecting the Power Supply

After checking all the connections, insert power cord into an outlet.

When the power supply is connected correctly, the POWER STANDBY indicator on the front panel of the amplifier lights up. A very small amount of power (5 W) is consumed under these conditions even if the amplifier remains turned off. To shut off the power completely, pull the power cord out of the socket.

⚠ CAUTION! Do not handle the power cord with wet hands.

Using the socket on the back of the amplifier

Use the socket on the back of the amplifier to connect the power supply of any audio components connected to this amplifier.

Upon turning on the amplifier POWER switch, power is supplied to the socket on the back of the amplifier. With their respective POWER switches turned on, the connected equipment turn on or off together with the amplifier POWER switch.

⚠ CAUTION! Do not connect any equipment that consume more power than the AC outlet (S) capacity. The AC outlet (S) capacity is indicated near the socket.

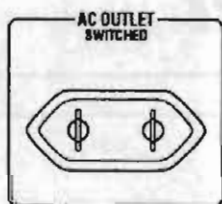

For Continental Europe

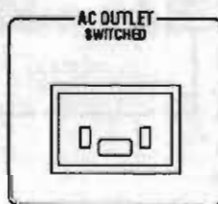

For the U.K.

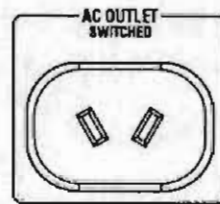

For Australia

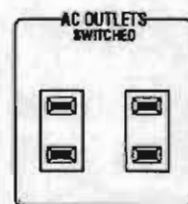

For other areas

Inserting Batteries into the Remote Controller

Before starting

The remote controller requires two batteries.
The remote controller and batteries are packaged together with the main unit of the amplifier.

Inserting batteries

Insert batteries into the remote controller as follows:

1. Slide the battery cover on the back of the remote controller while pressing it.
2. Insert batteries in the remote controller. Make sure that they are oriented with the proper polarity; (+) to (+) and (-) to (-).
3. Slide the battery cover back.



Replacing the batteries

In the range of the remote controller decreases, it is time to replace the batteries. Use R03/AAA (24F)/UM-4 type dry cells.

Notes: Follow the precautions below to avoid leaking or cracking cells.

- Orient batteries with proper polarity; (+) to (+) and (-) to (-).
- Use the correct type of batteries. (Batteries which look similar may differ in voltage.)
- Replace all two batteries.
- Do not attempt to heat or burn the batteries.

Basic Operation

In order to listen to the source equipment after the amplifier is turned on, do as described in order below:

Operating Procedure

Important! Operate the remote controller with its signal transmitting part pointed at the amplifier's remote sensor window. The remote controller is operable from a distance of up to 7 meters.

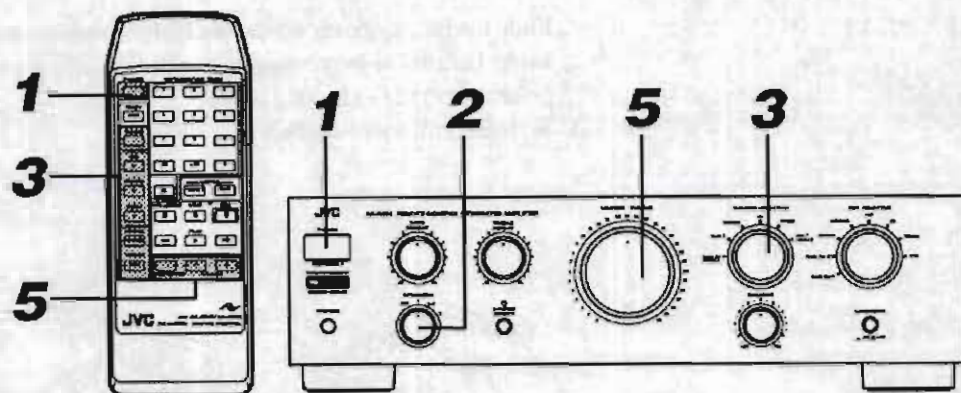

1. Turning on the power

Press the POWER switch to turn on the amplifier.

The POWER STANDBY indicator turns off, and the SOURCE SELECTOR switch and the REC SELECTOR switch indicators light up, thereby indicating that the amplifier is turned on.

Note: Pressing the POWER switch again turns off the amplifier and lights the POWER STANDBY indicator.

2. Selecting a speaker (see page 10)

Use the SPEAKERS switch to choose between the two sets of speakers.

The headphones can be used by inserting the PHONES jack to the appropriate socket in the amplifier.

3. Selecting a source (see page 9)

In order to choose the source you wish to listen to, use the SOURCE SELECTOR switch on the main unit of the amplifier or the TUNER, CD, PHONO, TAPE 1, TAPE 2/VIDEO 2, AUX/VIDEO 1 switches on the remote controller.

Use the REC SELECTOR switch to select the source for recording.

4. Operating the source equipment (see page 12)

Operate the source equipment according to their respective instruction manuals.

If your audio source equipment is connected to COMPU LINK-3 SYNCHRO jacks of this amplifier, you can operate it with this amplifier's remote controller.

5. Adjusting the volume and tone (see page 10)

Use the MASTER VOLUME control on the main unit of the amplifier or the VOLUME button on the remote controller to adjust the volume.

Apart from these controls, there are also various other functions that can be used to produce a desired volume or tone.

Selecting the Source

You can select the source you wish to hear or record from among the stereo equipment connected to the amplifier.

Selecting the Source You Wish to Hear

Selecting the Source You Wish to Hear

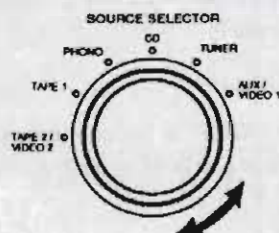

Use the SOURCE SELECTOR switch to choose the source. Indicator shows which source have been selected.

TAPE 2/VIDEO 2: Use this position to listen to the tape deck 2 or Video equipment connected to the TAPE 2/VIDEO 2 jacks.

TAPE 1: Use this position to listen to the tape deck 1.

PHONO: Use this position to listen to a record.

CD: Use this position to listen to a CD.

TUNER: Use this position to listen to the radio.

AUX/VIDEO 1: Use this position to listen to equipment connected to the amplifier's AUX/VIDEO 1 jacks.

Note: The dial can be revolved fully one rotation clockwise or counterclockwise.



Operation using the remote controller:

The source you wish to listen to can also be selected using the remote controller. Press one of the six buttons on the left side of the remote controller: TUNER, CD (▶), PHONO (▶), TAPE 1 (▶), TAPE 2 (VIDEO 2), AUX (VIDEO 1).

Selecting the Source for Recording

Selecting the Source for Recording

Use the REC SELECTOR switch to select the source for recording. Indicator shows which source have been selected.

Basically, the following two positions are used:

OFF: Use this position when recording is not required.

SOURCE: Use this position when recording is required.

The following six positions are available to record one source while listening to another source:

TAPE 2 ▶ 1: Use this position to record from the tape deck 2 or VIDEO equipment connected to the TAPE 2/VIDEO 2 jacks of the amplifier to the tape deck 1.

TAPE 1 ▶ 2: Use this position to record from the tape deck 1 to the tape deck 2.

PHONO: Use this position to record from a record.

CD: Use this position to record from a CD.

TUNER: Use this position to record from the radio.

AUX/VIDEO 1: Use this position to record from the equipment connected to the amplifier's AUX/VIDEO 1 jacks.

Note: The dial can be revolved fully one rotation clockwise or counterclockwise.

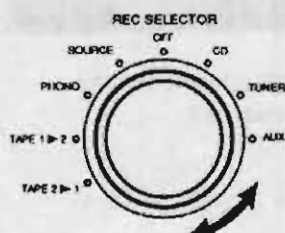

Adjusting the Volume and Tone

You can listen to the selected source at any desired volume and tone settings.

Note: The adjustments described here do not affect the recording.

Adjusting the Volume

Adjusting the Volume

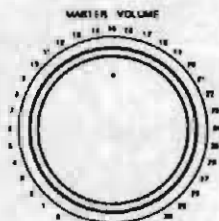

Use the MASTER VOLUME control to adjust the volume from the left and right channels. Rotating the dial to the right raises the volume, and to the left lowers the level. The volume from both sets of speakers and the headphones changes simultaneously.

Operation using the remote controller:

Volume can also be adjusted using the remote controller. Press the VOLUME button marked + on the remote controller to increase the volume or the VOLUME button marked – to decrease the volume.

Muting the Sound



Pressing the FADE MUTING button on the remote controller decreases the volume continuously to the mute mode. Use this button to mute the sound quickly when you received a telephone call or a visitor.

Note: Pressing the button once may not be sufficient to mute high volume. In such cases, press it again.

Selecting the Speakers



Use the SPEAKERS switch to select from the two sets of speakers connected to the amplifier. (Speakers 1/Speakers 2)

- 2: Use this position to use the Speakers 2.
- 1+2: Use this position to use both sets of speakers. (Speakers 1 and Speakers 2)
- 1: Use this position to use the Speakers 1.
- OFF: Use this position to use the headphones only (with no output from the speakers).

Adjusting the Balance and the Volume

Adjusting Balance between the right and left



Use the BALANCE control to adjust the volume balance of the right and left channels. This applies not only to the speaker sound but also to the headphone sound.

Adjusting Bass and Treble

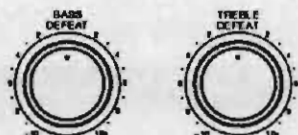

Use the BASS control to adjust a low-pitched sound and the TREBLE control to adjust a high-pitched sound. Turning either dial to the right intensifies the sound and turning to the left attenuates it. Setting the dial to “DEFEAT” leaves bass and treble unchanged. Use these dials to adjust the tone as desired.

Listening at Low Volume Level



Our ears are not sensitive to low- and high-frequency sounds when the volume is low. The Loudness control compensates for this hearing characteristic. It adjusts the bass and treble settings according to the level. In order to use the loudness function, press the LOUDNESS switch setting it to the “= ON” mode (with the button depressed). Pressing it again returns to the “■ OFF” mode (with the button not depressed), and the loudness function is cancelled.

Using a Graphic Equalizer

If a graphic equalizer is connected to the TAPE 2/VIDEO 2 jacks on the rear panel further subtle tone adjustments become possible. To listen to sounds after processing by the graphic equalizer, set the REC SELECTOR switch to the desired source and the SOURCE SELECTOR switch to TAPE 2/VIDEO 2.

Reproducing More Realistic Sounds

Source Direct function



Source Direct function realizes amplification as close as to the original sound by shortening the signal route. Press the SOURCE DIRECT switch to use this function. The indicator at the top of the switch lights up, thereby indicating that the Source Direct function is turned on. Pressing the switch again cancels the function and turns off the indicator. Use this function only when a satisfactory tone is being reproduced requiring no adjustment with the BALANCE control, the BASS control or the TREBLE control. Input signals selected by the SOURCE SELECTOR switch are output through the shortest possible route without passing through the BALANCE control circuit or the BASS control or TREBLE control circuit.

Notes: When the SOURCE DIRECT switch is ON, the following switches and controls do not function.

- BALANCE control
- BASS control
- TREBLE control

Operating the Source Equipment



The COMPU LINK remote control system automatically interlocks your audio equipment for simple operation.

COMPU LINK Remote Control System

Connecting the COMPU LINK SYNCHRO-3 jacks on the back of the amplifier to the audio equipment will enable you use the four functions below.

Equipment Remote Control

You can control the equipment via the REMOTE SENSOR on the amplifier using the amplifier's remote controller. For further details, see the next page.

Note: Direct the remote controller at the REMOTE SENSOR on the amplifier.

Automatic Source Selection

When the source equipment is set in the playing mode, the SOURCE SELECTOR switch on the amplifier is automatically set in the corresponding position. However, changing the SOURCE SELECTOR switch setting on the amplifier automatically brings the corresponding source equipment into the playing mode. The equipment previously in the playing mode stops playing after five seconds.

Synchronized Recording

As soon as a CD or record is set to play, the tape deck starts recording. To use this feature, follow the procedure below.

1. Put a tape in the deck and a disk in the CD player or turntable.
2. Simultaneously press the REC and PAUSE button on the tape deck to put it the REC/PAUSE state. Press the REC button and PAUSE button together, or the synchronized recording feature will not operate.
3. Press the PLAY button on the CD player or turntable.

As soon as the disk starts playing, the tape deck starts recording. When the disk end, the tape deck switches from the REC/PLAY mode to the REC/PAUSE mode, and stops four seconds later.

Notes:

- The REC SELECTOR switch is locked to "CD" or "PHONE" during synchronized recording and therefore cannot be switched.
- If your CD player is operated in the PROGRAM mode, a 4-second mute is recorded between tracks to enable the music scan feature of your tape deck to work.
- If the power for any connected equipment is shut off during synchronized recording, the system will not operate properly. In this case, you must start all over again.

Simple playing of CD's

To start playing, simply load the CD magazine into the CD changer-player.

Note: This function has been added to the "COMPULINK-3", an upgraded version of the "COMPULINK-1". Refer to the CD changer-player manual for details of this function.

Using the Remote Controller

By connecting the COMPU LINK jack to this amplifier, you can operate the audio source equipment with this amplifier's remote controller. Besides that, if your VCR is JVC product, you can operate it with this amplifier's remote controller.

Note: VCR is excluded from the COMPU LINK remote control system. When you operate the VCR, aim the remote controller at the VCR directly.

Simple Operation

The buttons on the simple operation unit are used to operate the CD player, turntable, cassette deck, tuner, or VCR.

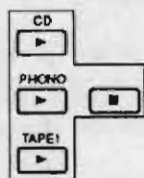

Pressing the ► button or ■ button on the simple operation unit allows the **CD player**, **turntable** or **cassette deck** to start or stop playing. Operate as follows:

- To operate the CD player, press the CD (►) button.
 - The CD player starts playing, and this can be stopped with the ■ button.
 - At this point, the numeric buttons can also be used. Refer to step 2 for details.

Press the PHONO (►) button to operate the turntable.

- The turntable starts playing, and this can be stopped with the ■ button.

Press the TAPE 1 (►) button to operate the cassette deck.

- The cassette deck starts playing, and this can be stopped with the ■ button.

- Pressing the CD (►) button brings the numeric buttons into the CD player mode. The track number can be specified using the numeric buttons.

Note: How to enter numbers with the numeric buttons differs according to the type of CD player. Refer to the instruction manual of your CD player for further information.

The **tuner's preset channel** and the **VCR's TV channel** can be set in the following manner using the numeric buttons on the simple operation unit:

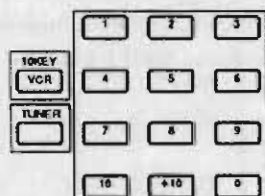

- To operate the tuner, press the TUNER button.
 - The Tuner becomes operable with the numeric buttons.

To operate the VCR, press the 10 KEY (VCR) button.

- The VCR becomes operable with the numeric buttons.

- Enter numbers using the numeric buttons.

Note: The response of each tuner or VCR to the numeric button operation differs depending on their type. Refer to the instruction manual for your tuner or VCR for further information.

Extended Operation

The buttons on the extended operation unit are used to operate the cassette deck or the VCR. These buttons permit various operations that are impossible using the buttons on the simple operation unit to be performed.

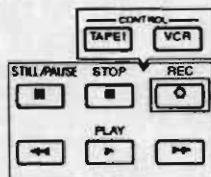

Operate the cassette deck in the following manner:

1. Press the CONTROL button marked TAPE 1.
The operation buttons are set to the cassette deck mode.
2. The following operation buttons are available:

- STILL/PAUSE (II):** Stops playing or recording temporarily.
Press the PLAY (▶) button to return to the original mode.
- STOP (■):** Stops operation.
- REC (○):** Pressing this button simultaneously with the PLAY (▶) button starts recording.
Pressing it simultaneously with the STILL/PAUSE (II) button operates the recording standby mode.
- ◀◀:** Fast winds the tape from right to left.
- PLAY (▶):** Starts playing.
- ▶▶:** Fast winds the tape from left to right.

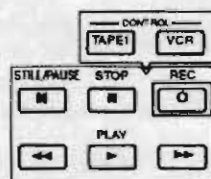

Operate the VCR as follows:

1. Press the CONTROL button marked VCR.
The operation buttons are set to the VCR mode.
 2. The following operation buttons are available.
- STILL/PAUSE (II):** Pressing this button during the playing operation freezes the image. Pressing it during the recording operation stops recording temporarily. Press the PLAY (▶) button to return to the original mode.
- STOP (■):** Stops operation.
- REC (○):** Pressing this button simultaneously with the PLAY (▶) button starts recording. Pressing it simultaneously with the STILL/PAUSE (II) button operates the recording standby mode.
- ◀◀:** Rewinds the tape.
- PLAY (▶):** Starts playing.
- ▶▶:** Fast forwards the tape.

TROUBLESHOOTING

Problem	Possible Cause	Solutions
Amplifier does not play.	Power cord not plugged in.	Plug Power cord into AC outlet.
No sound from any speakers.	SPEAKERS switch is set to OFF. The SOURCE SELECTOR switch is set incorrectly.	Turn SPEAKERS switch to ON. Select the desired source with the SOURCE SELECTOR switch.
Sound from one speaker only.	Speaker wires not connected properly. BALANCE control may be set to one extreme.	Check speaker wiring. Reconnect if needed. Adjust BALANCE control so both speakers have sound.
Howling during record playing.	Turntable too close to a speaker.	Move speakers away from the turntable.
Recording does not work.	The REC SELECTOR switch has been set incorrectly.	Set the REC SELECTOR switch to the desired source.

SPECIFICATIONS

Output Power (IEC 268-3/DIN):	80 watts per channel into 4 ohms at 1 kHz with no more than 0.7% total harmonic distortion. 60 watts per channel into 8 ohms at 1 kHz with no more than 0.7% total harmonic distortion. 50 watts per channel, min. RMS, both channels driven into 8 ohms from 20 Hz to 20 kHz, with no more than 0.007% total harmonic distortion.
Total harmonic distortion CD, TUNER, AUX/VIDEO 1, TAPE 1, TAPE 2/VIDEO 2 in SPEAKERS out:	0.003*% at 55 watts (at 1 kHz, 8 ohms loaded) 0.007*% at 50 watts (from 20 Hz to 20 kHz, 8 ohms loaded)
PHONO in, SPEAKER out:	0.05% at 50 watts (from 20 Hz to 20 kHz, 8 ohms loaded -30 dB volume)
Damping Factor:	90 (at 1 kHz, 8 ohms loaded)
Power bandwidth:	5 Hz to 50 kHz (IHF, both channels driven into 8 ohms, with no more than 0.05% total harmonic distortion)
Signal-to-noise ratio (*66 IHF/DIN) PHONO:	71 dB/67 dB
CD, TUNER, AUX/VIDEO 1, TAPE 1, TAPE 2/VIDEO 2:	100 dB/68 dB
Input Sensitivity/Impedance (1 kHz) PHONO:	2.5 mV/47 k ohms
CD, TUNER, AUX/VIDEO 1, TAPE 1, TAPE 2/VIDEO 2:	200 mV/47 k ohms
Output Level/Impedance (1 kHz) TAPE 1, TAPE 2/VIDEO 2:	200 mV /1 k ohms
Tone control range BASS:	±8 dB at 100 Hz
TREBLE:	±8 dB at 10 kHz
Frequency Response (8 ohms):	5 Hz to 80 kHz (+0 dB, -3 dB)
PHONO overload capacity (PHONO in, TAPE 2 REC out):	100 mV (with no more than 0.02% total harmonic distortion).
RIAA phono equalization:	±0.3 dB (20 Hz to 20 kHz)
Power requirement/Power consumption Continental Europe:	AC 230 volts ~, 50 Hz/220 watts
U.K., Australia:	AC 240 volts ~, 50 Hz/510 watts
Other Areas:	AC110/127/220/240 volts ~ selectable, 50/60 Hz/230 watts
Dimensions (W × H × D):	435 × 128 × 314 mm 17-3/16 × 5-1/16 × 12-3/8 inches
Weight:	7.7 kg 17.0 lbs

*Measured by JVC Audio Analysis System.
Design and Specifications subject to change without notice.

Description of Major ICs

■ MN171202JPP(IC201) : System Controller

1. Terminal Layout

VDD	1	64	OSC1
PHONO	2	63	OSC2
CD	3	62	VSS
TUNER	4	61	
AUX	5	60	GND
TAPE1	6	59	AC OUT
TAPE2	7	58	
DIRECT	8	57	SPK2
VOL. IND.	9	56	SPK1
REC. PHONO	10	55	
REC. CD	11	54	RM. IND.
REC. TUNER	12	53	VOL. DOWN
REC. AUX	13	52	VOL. UP
REC. TAPE1	14	51	
REC. TAPE2	15	50	
REC. SOURCE	16	49	
REC. OFF	17	48	DCS OUT
-Vpp	18	47	DCS IN
SWOUT1	19	46	
SWOUT2	20	45	INH. IN
SWOUT3	21	44	RM IN
SWOUT4	22	43	RESET
SWOUT5	23	42	S OUT
SWOUT6	24	41	SSTB
	25	40	SCK
	26	39	
S. SELECT1	27	38	
S. SELECT2	28	37	
R. SELECT1	29	36	
R. SELECT2	30	35	EXP/DO
SPK. SELECT	31	34	POWER SW
MUTE	32	33	S. DIRECT SW

2. Pin Function Description

Pin NO.	Symbol	I/O	Function and Operations	Pin NO.	Symbol	I/O	Function and Operations
1	VDD	--	Power supply	33	S. DIRECT SW	I	Input from Source Direct Switch (S261)
2	PHONO	O	Source IND. - PHONO (D221)	34	POWER SW	I	Input from Power Switch (S271)
3	CD	O	Source IND. - CD (D222)	35	EXP/DO	I	Chip select
4	TUNER	O	Source IND. - TUNER (D223)	36		--	Non connection
5	AUX	O	Source IND. - AUX / VIDEO1 (D224)	37		--	Non connection
6	TAPE1	O	Source IND. - TAPE1 (D225)	38		--	Non connection
7	TAPE2	O	Source IND. - TAPE2 / VIDEO2 (D226)	39		--	Non connection
8	DIRECT	O	Source Direct IND. (D451)	40	SCK	O	Clock for the Analog Switch (IC391,392)
9	VOL. IND.	O	Volume IND. (D442)	41	SSTB	O	Strobe for the Analog Switch (IC391,392)
10	REC. PHONO	O	REC. Selector IND. - PHONO (D241)	42	SOUT	O	Data for the Analog Switch (IC391,392)
11	REC. CD	O	REC. Selector IND. - CD (D242)	43	RESET	I	Input from Reset signal
12	REC. TUNER	O	REC. Selector IND. - TUNER (D243)	44	RM. IN	I	Input from the REMOTE SENSOR (IC271)
13	REC. AUX	O	REC. Selector IND. - AUX (D244)	45	INH. IN	I	Inhibit signal from the Reset IC (IC202)
14	REC. TAPE1	O	REC. Selector IND. - TAPE1 ▶ 2 (D245)	46		--	Non connection
15	REC. TAPE2	O	REC. Selector IND. - TAPE2 ▶ 1 (D246)	47	DCS IN	I	Input from Compulink signal
16	REC. SOURCE	O	REC. Selector IND. - SOURCE (D247)	48	DCS OUT	O	Output for Compulink signal
17	REC.OFF	O	REC. Selector IND. - OFF (D248)	49		--	Non connection
18	-Vpp	--	Power supply (-B)	50		--	Non connection
19	KEYOUT1	O	Rotary Switch Scan Out - 1	51		--	Non connection
20	KEYOUT2	O	Rotary Switch Scan Out - 2	52	VOL. UP	O	Output for the Volume UP Signal (IC441)
21	KEYOUT3	O	Rotary Switch Scan Out - 3	53	VOL. DOWN	O	Volume DOWN Signal (IC441)
22	KEYOUT4	O	Rotary Switch Scan Out - 4	54	RM. IND.	O	Remote Control IND. (D271)
23	KEYOUT5	O	Rotary Switch Scan Out - 5	55		--	Non connection
24	KEYOUT6	O	Rotary Switch Scan Out - 6	56	SPK1	O	Speaker Relay Control Signal (RY501)
25		--	Non connection	57	SPK2	O	Speaker Relay Control Signal (RY502)
26		--	Non connection	58		--	Non connection
27	S. SELECT1	I	Source Select Input - 1 (S261)	59	AC OUT	O	AC Relay Control Signal (RY001)
28	S. SELECT2	I	Source Select Input - 2 (S261)	60	GND	--	Connected to GND
29	R. SELECT1	I	REC. Select Input - 1 (S262)	61		--	Non connection
30	R. SELECT2	I	REC. Select Input - 2 (S262)	62	VSS	--	Connected to GND
31	SPK. SELECT	I	Speaker Select Input (S263)	63	OSC2	O	Clock oscillation Output
32	MUTE	O	Output for the Muting Signal (Q417,418)	64	OSC1	I	Clock oscillation Input

■ TC9163N, TC9164N (IC391, 392) : Analog Switch

1. Functions

These analog switches are controlled by 14 bit serial data from computer for selecting the source.

2. Terminal Layout & Block diagram

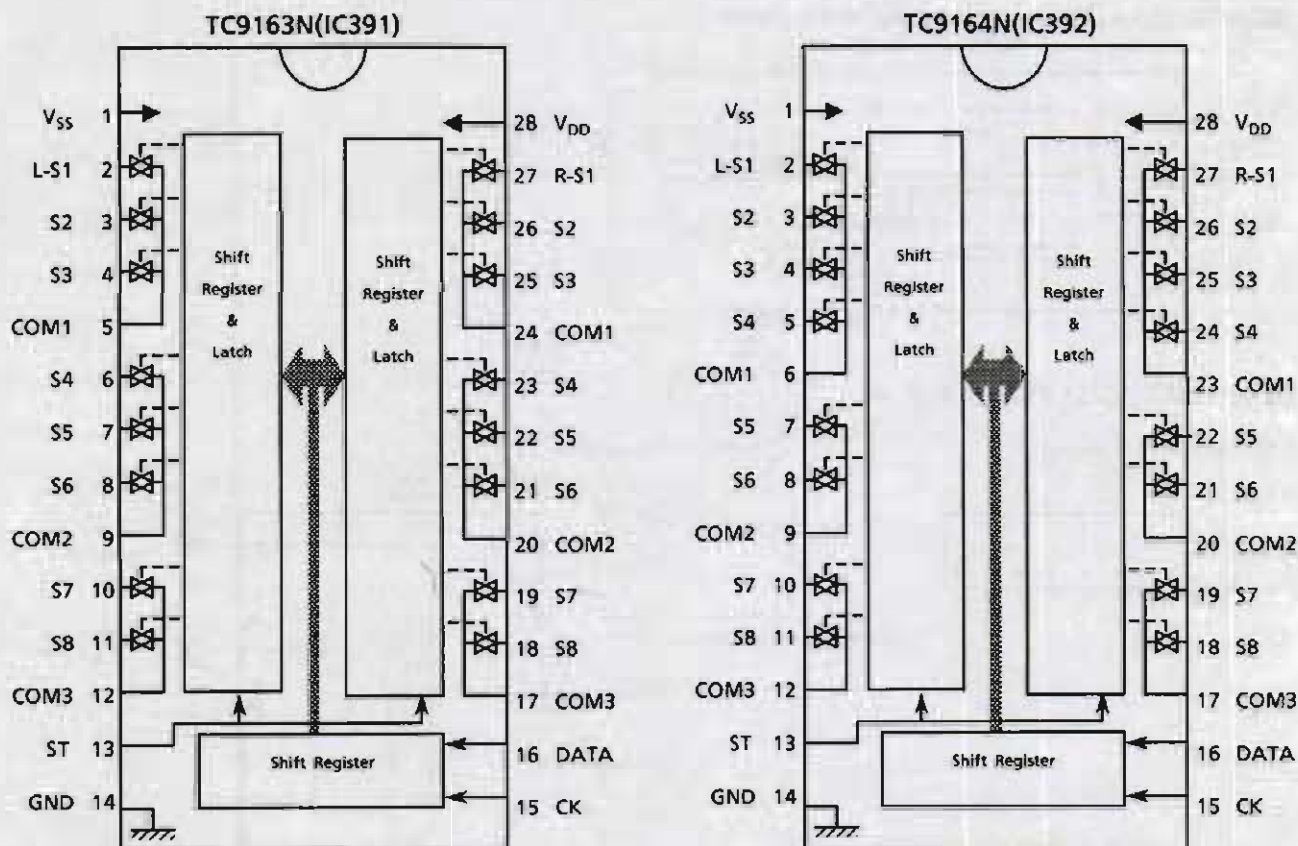

3. First 10bits are used to source select. Last 4 bits are chip select. The switches (S1~S8) are connected to common terminals (COM1~COM3) according to the DATA from computer.

	Switch Select bit								CH1 CH2 (L-S1~S8)(R-S1~S8)		Chip Select bit			
	S1	S2	S3	S4	S5	S6	S7	S8	S9	S10	S11	S12	S13	S14
TC9163N	The switch is ON when the data is "1".										1	0	0	0
TC9164N											0	1	0	0

Internal Block Diagram of Other ICs

■ LB1639-CV (IC402) : Motor Driver

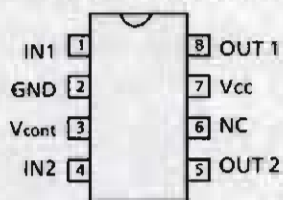

IN 1	IN 2	OUT 1	OUT 2	MOTOR
H	L	H	L	CLOCKWISE
L	H	L	H	COUNTER-CLOCKWISE
H	H	OFF	OFF	WAITING
L	L	OFF	OFF	WAITING

■ UPC1237HA (IC 901) : Protector, Relay Driver

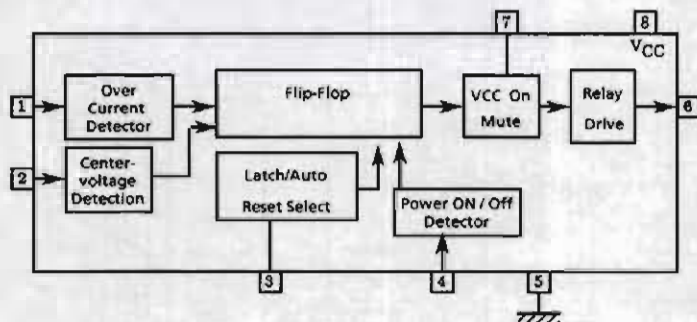

■ VC5022-2 (IC751,752): SUPER A

(1) Terminal Layout

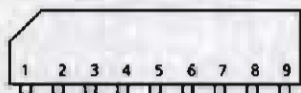

(2) Block Diagram

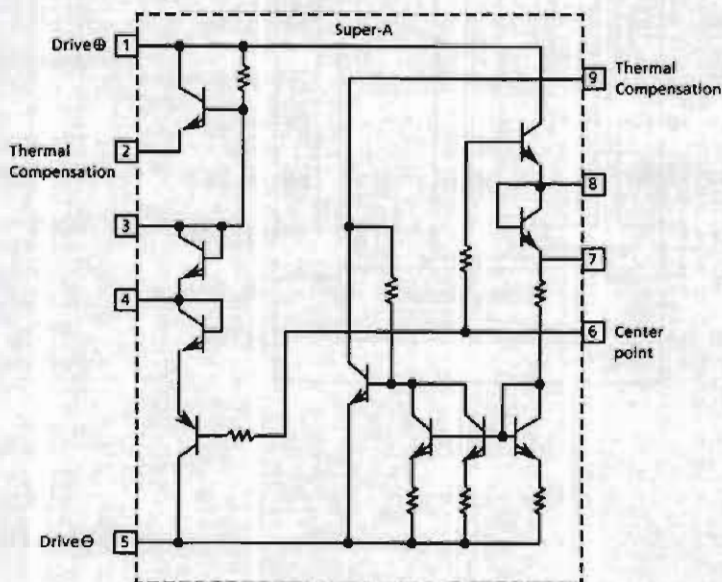

■ GP1U501X (IC271) : Receiver for remote controller

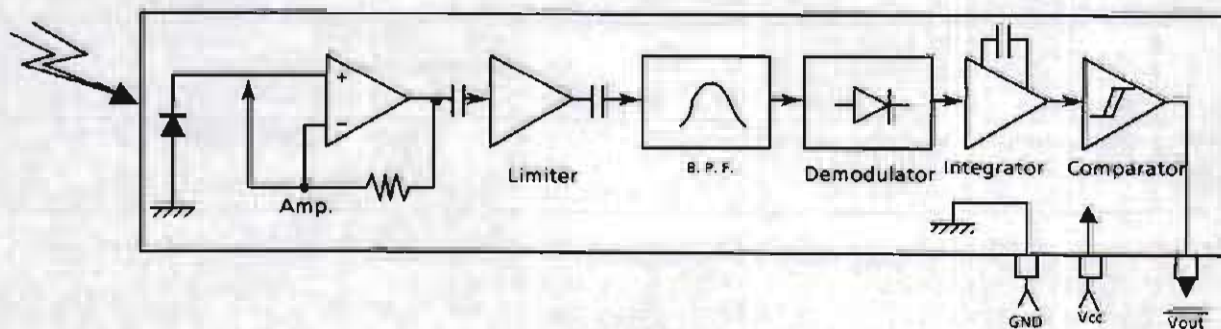

Remote Control Unit (RM-SA561U)

■ Schematic Diagram

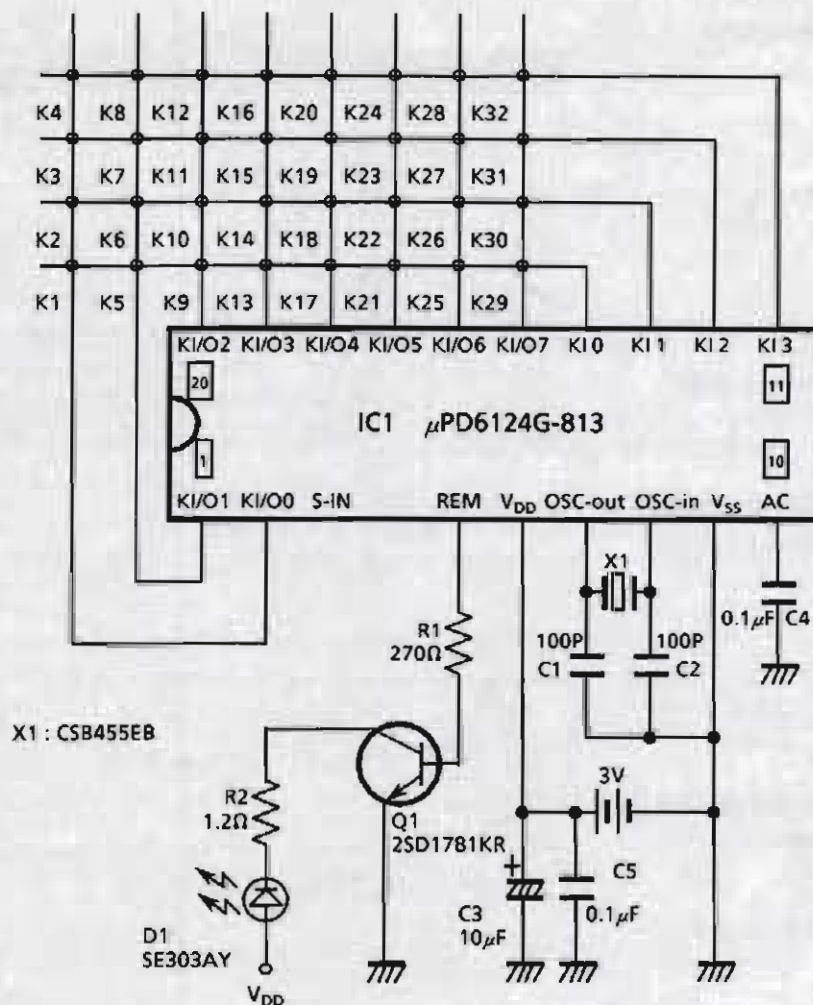

KEY NO.	KEY FUNCTION
1	3
2	2
3	1
4	POWER
5	6
6	5
7	4
8	TAPE 1 CONTROL
9	9
10	8
11	7
12	VCR CONTROL
13	0
14	+ 10
15	10
16	10 KEY VCR
17	■ VIDEO 1 AUX
18	VIDEO 1 AUX
19	TAPE 2 VIDEO 2
20	TUNER
21	REC ○
22	▶ STILL / PAUSE
23	▶ STILL / PAUSE
24	CD ▶
25	▶▶
26	STOP ■
27	◀◀
28	PHONO ▶
29	VOLUME +
30	VOLUME -
31	FADE MUTING
32	TAPE 1 ▶

■ Key Layout

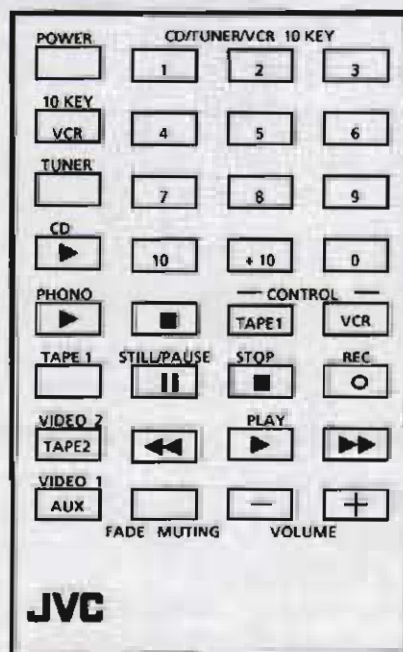

Disassembly Procedures

1. Removing the Top Cover

- 1) Remove the 4 screws fastening both sides of the Top Cover, and the 2 screws fastening the rear sides.
- 2) Remove the Top Cover.

2. Removing the Bottom Cover

- 1) Remove the 17 screws (A) (B) (C) (Fig.3).
- 2) Remove the Bottom Cover.

3. Removing the Front Panel

- 1) Remove the 3 revets (A) fastening top of the Front Panel (Fig.1), and the 5 screws (C) fastening bottom of the Front Panel (Fig.3).
- 2) Disconnect the connector P441 of Master Volume PCB (Fig.1), then remove the MASTER VOLUME knob.
- 3) Remove the 6 knobs (SOURCE SELECTOR, REC SELECTOR, BALANCE, TREBLE, BASS, SPEAKERS knob).
- 4) Remove the Front Panel.

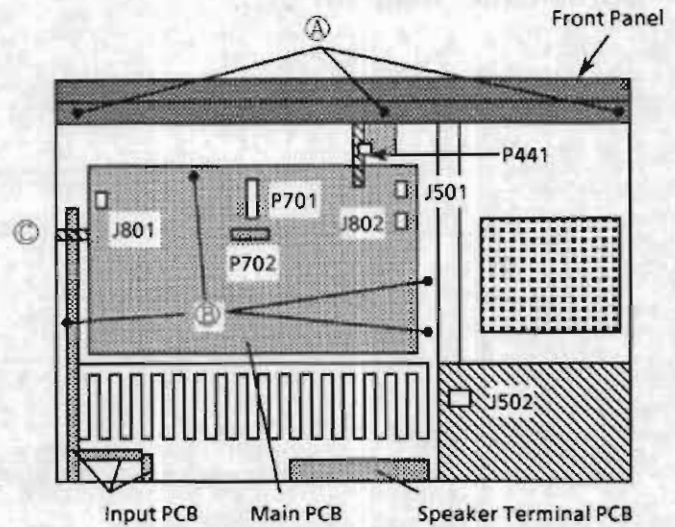

Fig 1. Top View

4. Removing the Input PCB

- 1) Remove the 5 screws (D) fastening the Input Terminal (Fig.2) and release the rebet (C) fastening the Input PCB (Fig.1).
- 2) Remove the 2 screws (I) fastening the Bottom Cover (Fig.3) and remove the 3 screws (E) fastening the Rear Panel (Fig.2).
- 3) Remove the connector J801 (Fig.1).
- 4) Remove the 2 connectors P431 and J202 of the Input PCB.
- 5) Remove the Input PCB.

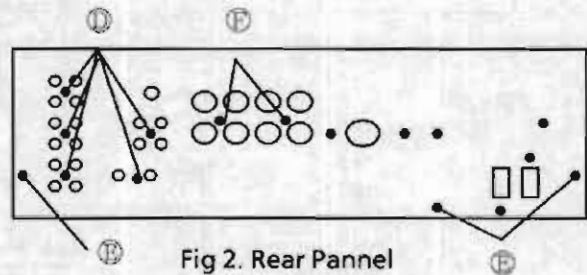

Fig 2. Rear Panel

5. Removing the Speakers Terminal PCB

- 1) Remove the 2 screws (E) fastening the Speakers Terminal (Fig.2).
- 2) Remove the 5 screws (D) fastening the Input Terminal and remove the 3 screws (E) fastening the Rear Panel (Fig.2).
- 3) Remove the Speakers Terminal PCB.

6. Remove the Main PCB with the Heatsink

- 1) Remove the 2 screws (H) fastening the Heatsink (Fig.3).
- 2) Remove the Input PCB. (Refer to the procedure of item 4.)
- 3) Remove the 4 screws (B) (Fig.1).
- 4) Remove the Speakers Terminal PCB. (Refer to the procedure of item 5.)
- 5) Remove the 6 connectors J801, J802, J501, J502, P701 and P702 (Fig.1).
- 5) Remove the Main PCB with the Heatsink.

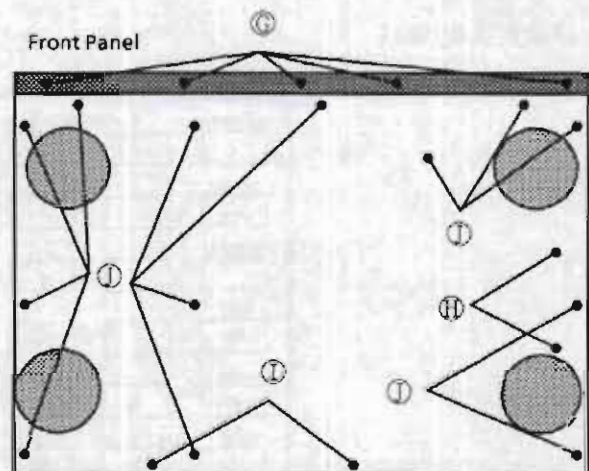
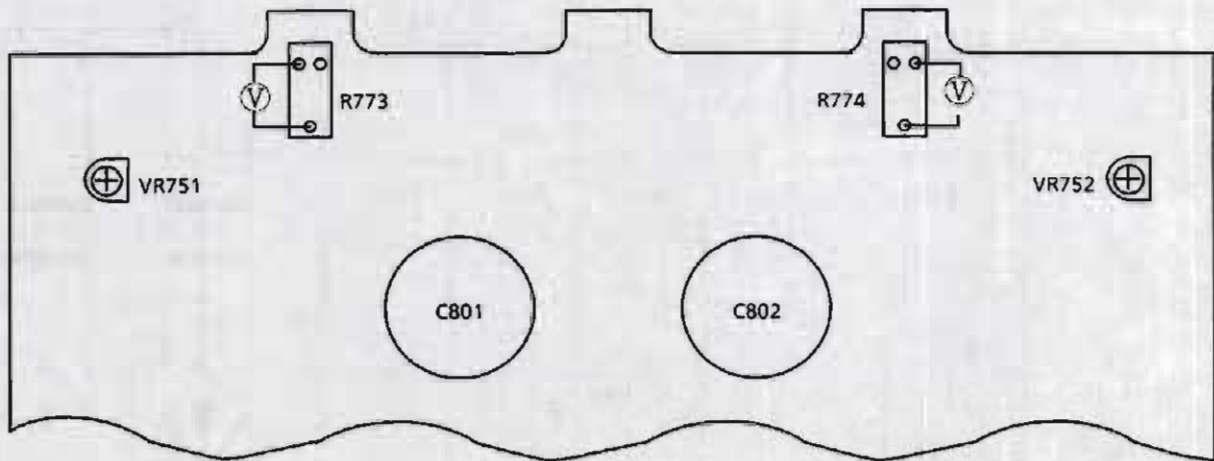

Fig 3. Bottom Cover

Power Amplifier Adjustment Procedures



■ Idling Current

- (1) Set the volume control to minimum during this adjustment.
- (2) Turn VR751 and VR752 fully counterclockwise before the power switch on.
- (3) Always start from cold, and allow 15 minutes to warm up before adjustment. If the heatsink is already warm from previous use the correct adjustment can not be made.
- (4) Connect a DC voltmeter to R773 resistor's leads for left channel, or to R774 for right channel.
- (5) Adjust VR751 for left channel, or VR752 for right channel, so that the DC voltmeter becomes 7mV ~ 15mV.

Block Diagram

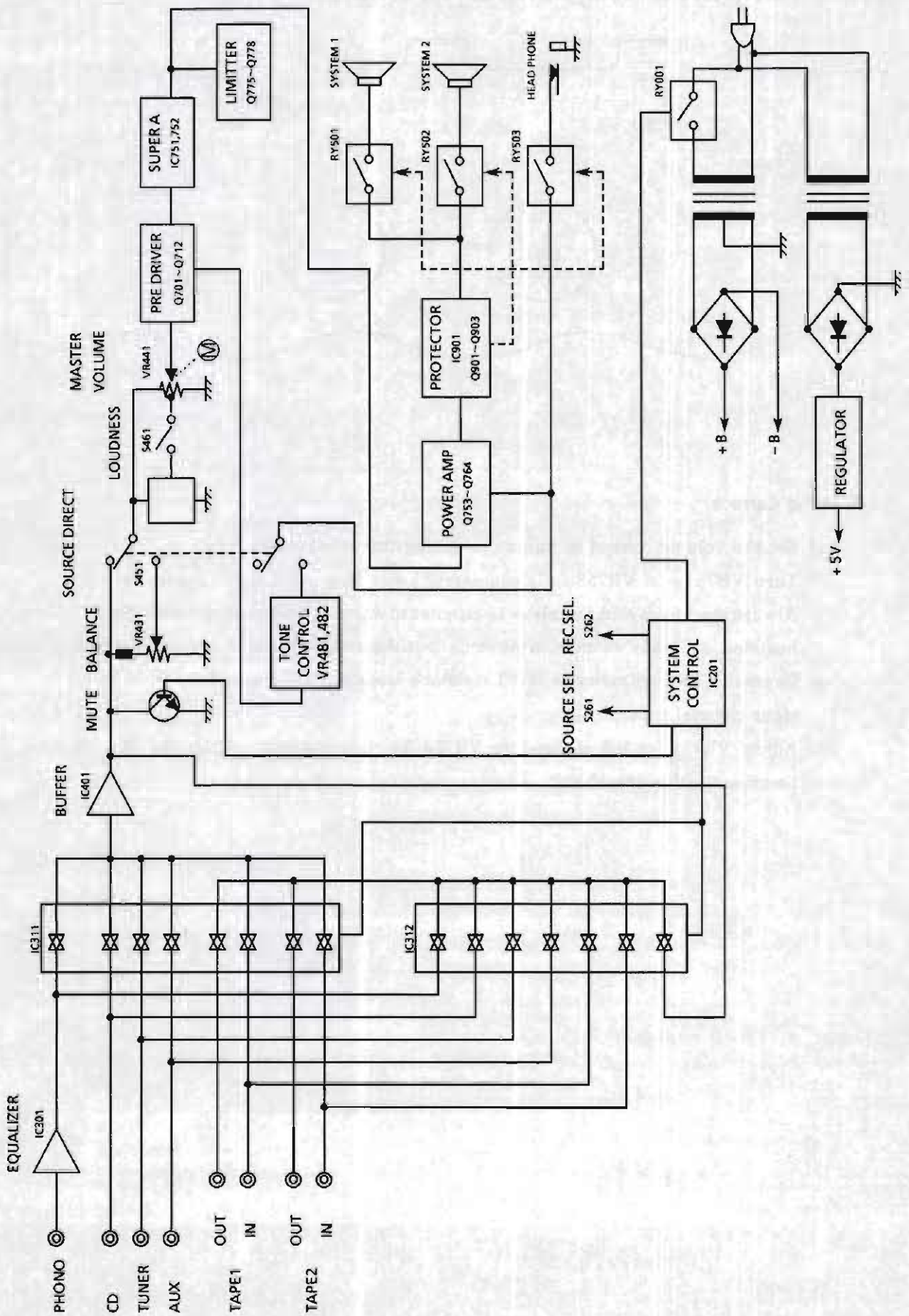

■ Main Amplifier & Power Supply PCB (ENH-210)

Note: This PCB is used for EXCEPT units with following manufacturing and versions.

- AX-R561TN Continental Europe #12700001 ~ #12700521
Universal Type #12700001 ~ #12700314
- AX-R562BK Continental Europe #12700001 ~ #12700520

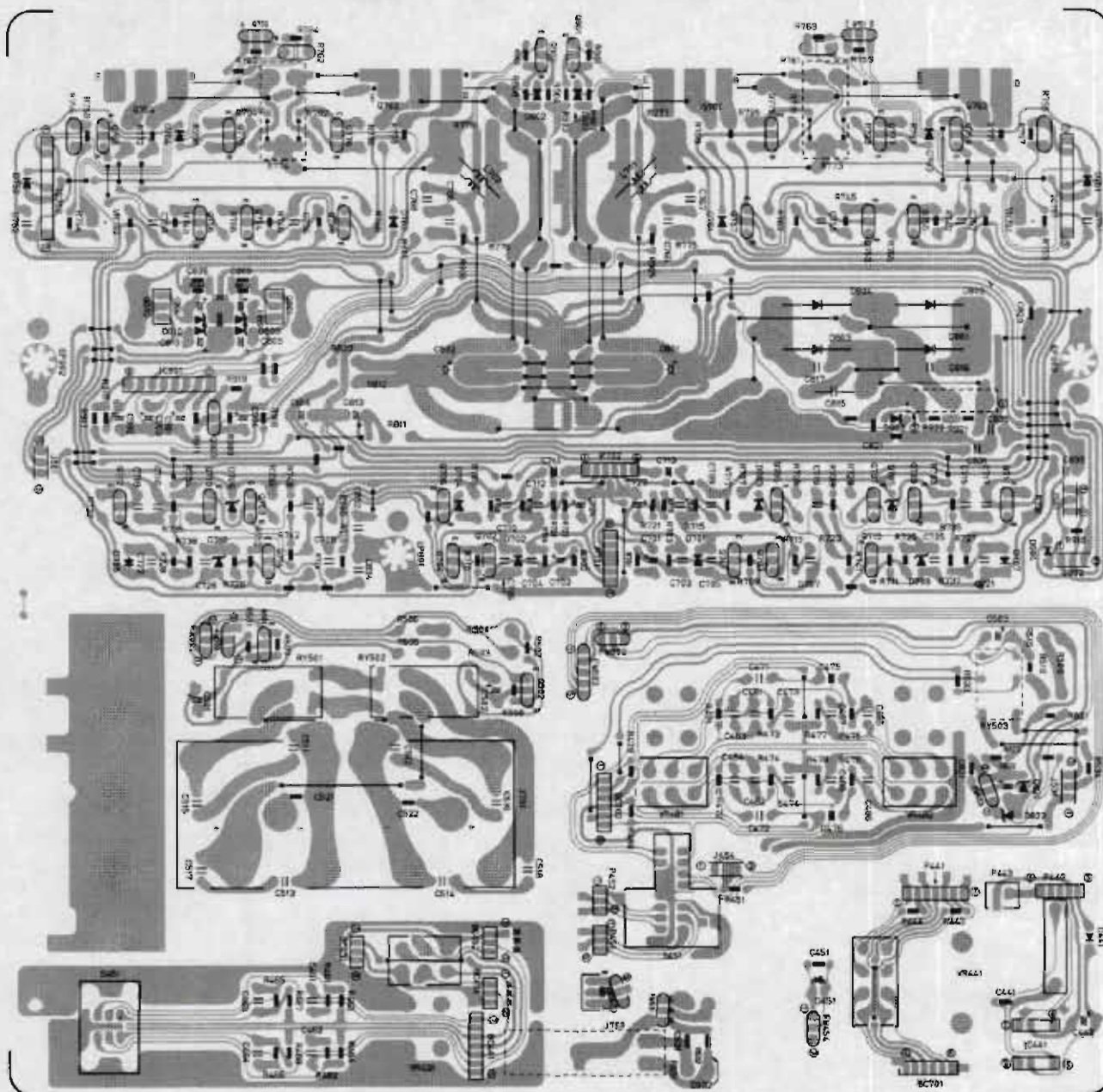

- MEMO -

PARTS LIST

Contents

General Exploded View and Parts List	2-2
Printed Circuit Board Ass'y and Parts List	2-7
■ ENE-084 <input type="checkbox"/> Input & Front PC Board	2-7
■ ENH-210 <input type="checkbox"/> Main Amplifier & Power Supply PC Board	2-10
Accessories List	2-13
Packing Materials and Part Numbers	2-14

General Exploded View and Parts List

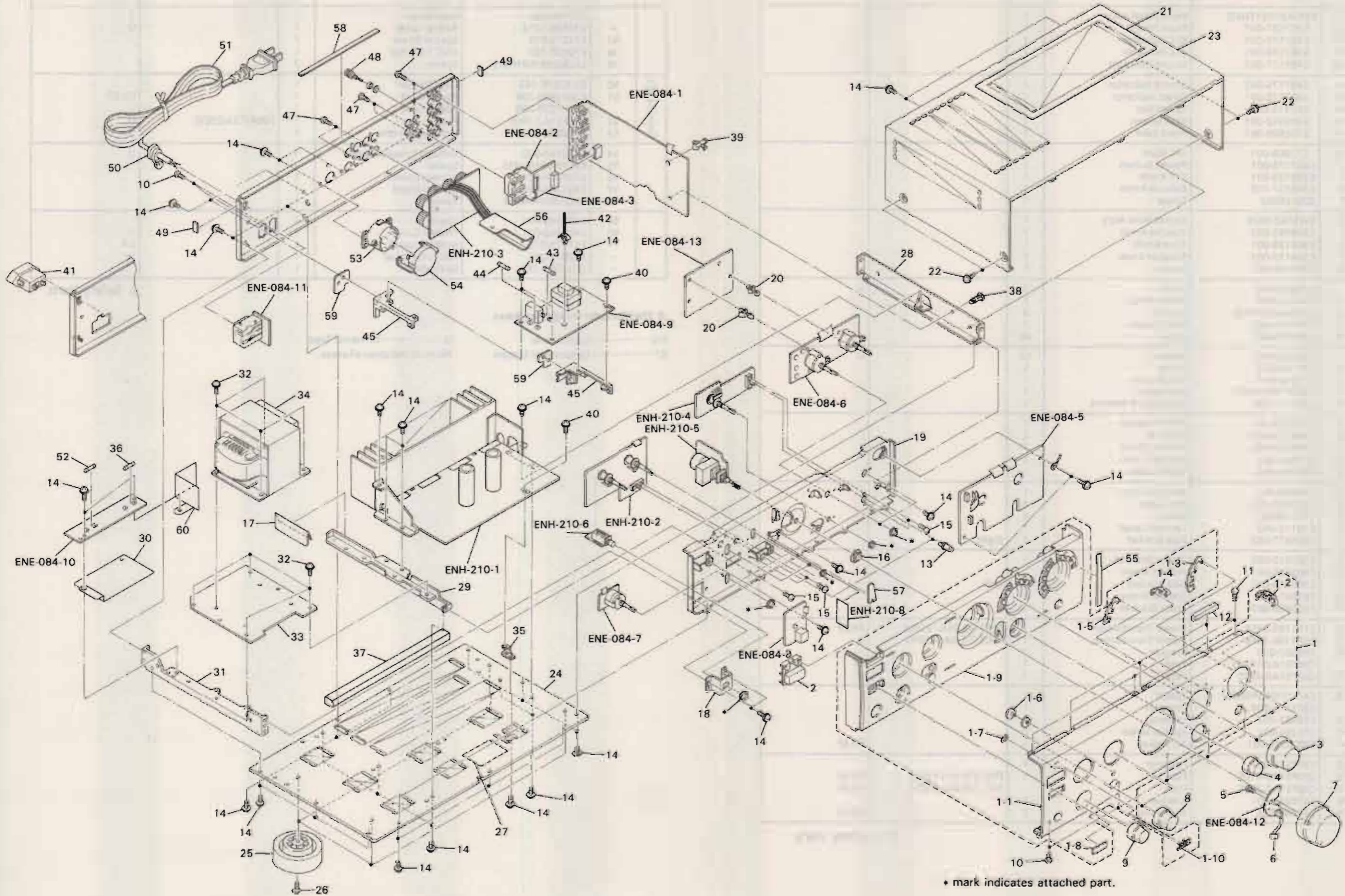

■ Parts List

△	Item	Part Number	Part Name	Q'ty	Description	Areas
	1	EFP-AXR561TNE(S)	Front Panel Ass'y	1		
	1-1	E207527-001	Front Panel	1		
	1-2	E407177-001	REC Indicator	1		
	1-3	E407176-001	REC Indicator	1		
	1-4	E407177-002	Source indicator	1		
	1-5	E407176-002	Source Indicator	1		
	1-6	E407178-001	Direct Indicator	1		
	1-7	E60912-003	Speed Nut	1		
	1-8	E406592-001	REM Screen	1		
	1-9	E102609-001	Front Base	1		
	1-10	E72968-001	JVC Mark	1		
	2	E407173-001	Power Button	1		
	3	E308139-001	REC Knob	2		
	4	E308137-005	Balance Knob	1		
	5	SDSF2608Z	Screw	1		
	6	EWS142-002B	Socket Wire Ass'y	1		
	7	E308095-003	Volume Knob	1		
	8	E308138-001	Tone Knob	1		
	9	E308137-003	Speaker Knob	1		
	10	SDSG3008CC	Screw	5		
	11	SDSG3008CC	Screw	7		U
	12	E48729-009	Plastic Rivet	3		
	13	EXO060007N40S	Spacer	3		
	14	E407110-003	Push Button	2		
	14	GBSG3008CC	Screw	40		
	15	GBSG3008CC	Screw	43		U
	16	SBST3006CC	Screw	5		
	17	E71862-001	Volume Nut	1		
	18	EXO075010H05S	Felt Spacer	2		
	18	E407111-001	Headphone Bracket	1		
	19	E207529-001	Front Bracket	1		
	20	E306232-005	Fastener	2		
	21	E306233-002	Protect Sheet	1		
	22	E61660-004	Special Screw	4		
	23	E26753-002	Metal Cover	1		
	24	E26273-003	Bottom Cover	1		
	25	E307427-003	Foot Ass'y	4		
	26	GBST3008CC	Screw	4		
	27	E70115-002	Caution Label	1		
	28	E305811-002	Side Bracket	1	Right	
	29	E305812-002	Center Bracket	1		
	30	E406626-001	Protect Sheet	1		
	31	E305810-001	Side Bracket	1	Left	
	32	E61661-005	Special Screw	8		
	33	E305803-007	Trans Bracket	1		
△	34	ETP1100-32EB	Power Transformer	1	F003 (T1.25A / 250V)	EN,EF
△	35	ETP1100-32FB	Power Transformer	1	F003 (T4.0A / 250V)	U
△	36	E68587-008	Bracket	1		
△	37	QMF51A2-1R25S	Fuse	1		EF
△	37	QMF51A2-4R0S	Fuse	1		U
	38	EXO255005N60S02	Spacer	1		
	39	E303216-006	Fastener	1		
	40	E69384-002	Fastener	1		
△	40	E74266-002	Special Screw	2		
△	41	EMC0236-001	AC Socket	1		EN,EF
△	42	E307572-001	Fastener	1		
△	43	QMF51A2-R10S	Fuse	1	F002 (T0.1A / 250V)	EN,EF
△	44	QMF51A2-2R0S	Fuse	1	F001 (T2.0A / 250V)	EN,EF
	45	E406074-001	Bracket	1		
	46	E26740-036	Rear Panel	2		EN,EF

△ : Safety Parts

△	Item	Part Number	Part Name	Q'ty	Description	Areas
	-	E26740-037	Rear Panel	1		U
	47	E308287-012	Rating Label	1		U
	47	E73273-003	Special Screw	7		
	48	E70078-003	GND Terminal	1		
	49	EXO020010R10S10	Spacer	2		
△	50	QHS3876-162	Cord Stopper	1		
△	51	QMP3900-200	Power Cord	1		EN,EF
△	51	QMP7520-200	Power Cord	1		U
△	52	QMF51A2-2R0S	Fuse	1	F004 (T2A/250V)	U
△	53	QSR0085-018	Voltage Selector	1		U
	54	E302764-002	Voltage Selector Cover	1		U
	55	EXO060010H03S	Spacer	1		
	56	E407327-001	Protect Cover	1		
	57	E407344-001	Protect Sheet	1		
	58	EXO150010N20S	Spacer	1		
	59	E407345-001	Spacer	2		
	60	E407362-001	Protect Cover	1		U
	-	E61029-005	Number Label	1		EN
	-	E70027-001	Approval Label	1		EF
	-	QZL1031-101	SEV Label	1		

△ Safety Parts

★ The Marks for Designated Areas

EN Scandinavia
 EF Continental Europe
 U Universal Type
 No mark indicates all areas.

Printed Circuit Board Ass'y and Parts List

■ ENE-084 □ Input & Front PC Board

Note: ENE-084 □ varies according to the areas employed. See note (1) when placing an order.

※ All printed circuit board assemblies are not available as service parts.

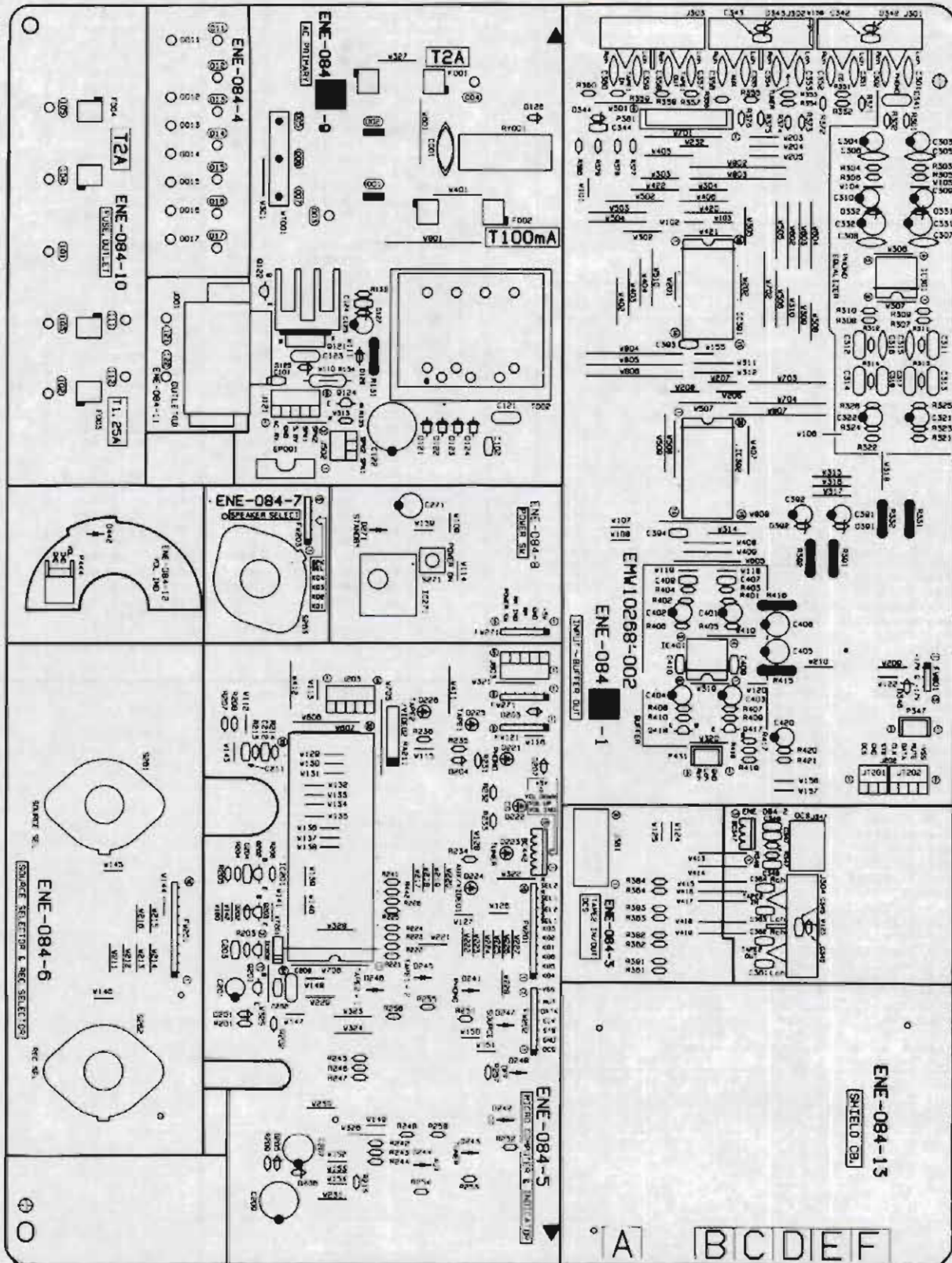

Note (1)

PC Board Ass'y	Designated Areas
ENE-084 B	Scandinavia
ENE-084 F	Continental Europe
ENE-084 C	Universal Type

Transistors

ITEM	PART NUMBER	DESCRIPTION	AREA
Q121	2SD1944(J,K)	SILICON ROHM	C
Q122	2SC2235(D,Y)	SILICON TOSHIBA	
Q124	2SC2060(Q,R)	SILICON ROHM	
Q201	DTC114YS	SILICON ROHM	
Q202	2SC1740S(R,S)	SILICON ROHM	
Q203	DTA124ES	SILICON 0021	
Q417	2SC287B(A,B)	SILICON TOSHIBA	
Q418	2SC287B(A,B)	SILICON TOSHIBA	

△ : SAFETY PARTS

I.C.s

ITEM	PART NUMBER	DESCRIPTION	AREA
IC201	MN171202JPP	I.C.	
IC202	PST7046T0	I.C. MITSUMI	
IC271	GP1U501X	I.C. SHARP	
IC301	VC4580DD	I.C. DAINICHI	
IC391	TC9163N	I.C. TOSHIBA	
IC392	TC9164N	I.C. TOSHIBA	
IC401	VC4580D	I.C. DAINICHI	

△ : SAFETY PARTS

Diodes

ITEM	PART NUMBER	DESCRIPTION	AREA
△ D121	ERA15-02L19	SILICON KYOUDOU	
△ D122	ERA15-02L19	SILICON KYOUDOU	
△ D123	ERA15-02L19	SILICON KYOUDOU	
△ D124	ERA15-02L19	SILICON KYOUDOU	
D125	MTZ12JC	ZENER ROHM	C
D126	MTZ12JC	ZENER ROHM	B
D126	1SS119	SILICON HITACHI	C
D126	MTZ12JC	ZENER ROHM	F
D127	RD6.2JSB3	ZENER NEC	
D201	1SS119	SILICON HITACHI	
D202	1SS119	SILICON HITACHI	
D203	1SS119	SILICON HITACHI	
D204	1SS119	SILICON HITACHI	
D205	1SS119	SILICON HITACHI	
D207	1SS119	SILICON HITACHI	
D221	SLR-34DC3F	L.E.D. ROHM	
D222	SLR-34DC3F	L.E.D. ROHM	
D223	SLR-34DC3F	L.E.D. ROHM	
D224	SLR-34DC3F	L.E.D. ROHM	
D225	SLR-34DC3F	L.E.D. ROHM	
D226	SLR-34DC3F	L.E.D. ROHM	
D241	SLR-342VCA47	L.E.D.	
D242	SLR-342VCA47	L.E.D.	
D243	SLR-342VCA47	L.E.D.	
D244	SLR-342VCA47	L.E.D.	
D245	SLR-342VCA47	L.E.D.	
D246	SLR-342VCA47	L.E.D.	
D247	SLR-342VCA47	L.E.D.	
D248	SLR-342VCA47	L.E.D.	
D271	SLR-342VCA47	L.E.D.	
D342	MTZ3.3JB	ZENER ROHM	
D345	MTZ3.3JB	ZENER ROHM	
D346	MTZ3.3JB	ZENER ROHM	
D348	1SS119	SILICON HITACHI	
D442	SLR-342VCA47	L.E.D.	

△ : SAFETY PARTS

Capacitors

ITEM	PART NUMBER	DESCRIPTION	AREA
△ C001	QCZ9050-103A	0.01MF CERAMIC	
C101	QCHB1E2-223	0.022MF 25V CERAMIC	
C121	QFN81HJ-473	0.047MF 50V MYLAR	B
C121	QFN32AJ-473Z	0.047MF 100V MYLAR	C
C121	QFN81HJ-473	0.047MF 50V MYLAR	F
C122	QETB1EM-477	470MF 25V ELECTRO	B
C122	QETB1JM-477	470MF 63V ELECTRO	C
C122	QETB1EM-477	470MF 25V ELECTRO	F
C123	QFN82AJ-103	0.01MF 100V MYLAR	C
C124	QCVB1CM-103	0.01MF 16V CERAMIC	
C125	QETB1CM-476	47MF 16V ELECTRO	
C201	QETB1HM-225	2.2MF 50V ELECTRO	
C202	QCVB1CM-103	0.01MF 16V CERAMIC	
C203	QCVB1CM-103	0.01MF 16V CERAMIC	
C204	QCGB1HK-102	1000PF 50V CERAMIC	
C207	QETB0JM-477	470MF 6.3V ELECTRO	
C208	QCZ0203-155	1.5MF 25V CERAMIC	
C209	QETB0JM-108	1000MF 6.3V ELECTRO	
C211	QCVB1CM-103	0.01MF 16V CERAMIC	
C212	QCVB1CM-103	0.01MF 16V CERAMIC	
C271	QERS0JM-107	100MF 6.3V ELECTRO	
C303	EETB1HM-106E	10MF 50V ELECTRO	
C304	EETB1HM-106E	10MF 50V ELECTRO	
C307	QCS21HJ-101	100PF 50V CERAMIC	
C308	QCS21HJ-101	100PF 50V CERAMIC	
C309	EETB0JM-107E	100MF 6.3V ELECTRO	
C310	EETB0JM-107E	100MF 6.3V ELECTRO	
C311	QFN81HJ-472	4700PF 50V MYLAR	
C312	QFN81HJ-472	4700PF 50V MYLAR	
C313	QFVB1HJ-153N	0.015MF 50V T.FILM	
C314	QFVB1HJ-153N	0.015MF 50V T.FILM	
C315	QCS21HJ-331	330PF 50V CERAMIC	
C316	QCS21HJ-331	330PF 50V CERAMIC	
C317	QFN81HJ-272	2700PF 50V MYLAR	
C318	QFN81HJ-272	2700PF 50V MYLAR	
C321	EETB1HM-106E	10MF 50V ELECTRO	
C322	EETB1HM-106E	10MF 50V ELECTRO	
C331	EETB1CM-107E	100MF 16V ELECTRO	
C332	EETB1CM-107E	100MF 16V ELECTRO	
C341	QFVB1HJ-103N	0.01MF 50V T.FILM	
C347	QCB1HK-221	220PF 50V CERAMIC	
C349	QCB1HK-102	1000PF 50V CERAMIC	
C391	EETB1EM-476E	47MF 25V ELECTRO	
C392	EETB1EM-476E	47MF 25V ELECTRO	
C393	QCB1HK-221	220PF 50V CERAMIC	
C394	QCB1HK-221	220PF 50V CERAMIC	
C401	EETB1HM-106E	10MF 50V ELECTRO	
C402	EETB1HM-106E	10MF 50V ELECTRO	
C403	EETB1HM-106E	10MF 50V ELECTRO	
C404	EETB1HM-106E	10MF 50V ELECTRO	
C405	EETB1EM-476E	47MF 25V ELECTRO	
C406	EETB1EM-476E	47MF 25V ELECTRO	
C420	EETB1HM-105E	1MF 50V ELECTRO	

△ : SAFETY PARTS

■ ENH-210 □ Main Amplifier & Power Supply PC Board

Note : ENH-210 □ varies according to the areas employed. See note (1) when placing an order.

※ All printed circuit board assemblies are not available as service parts.

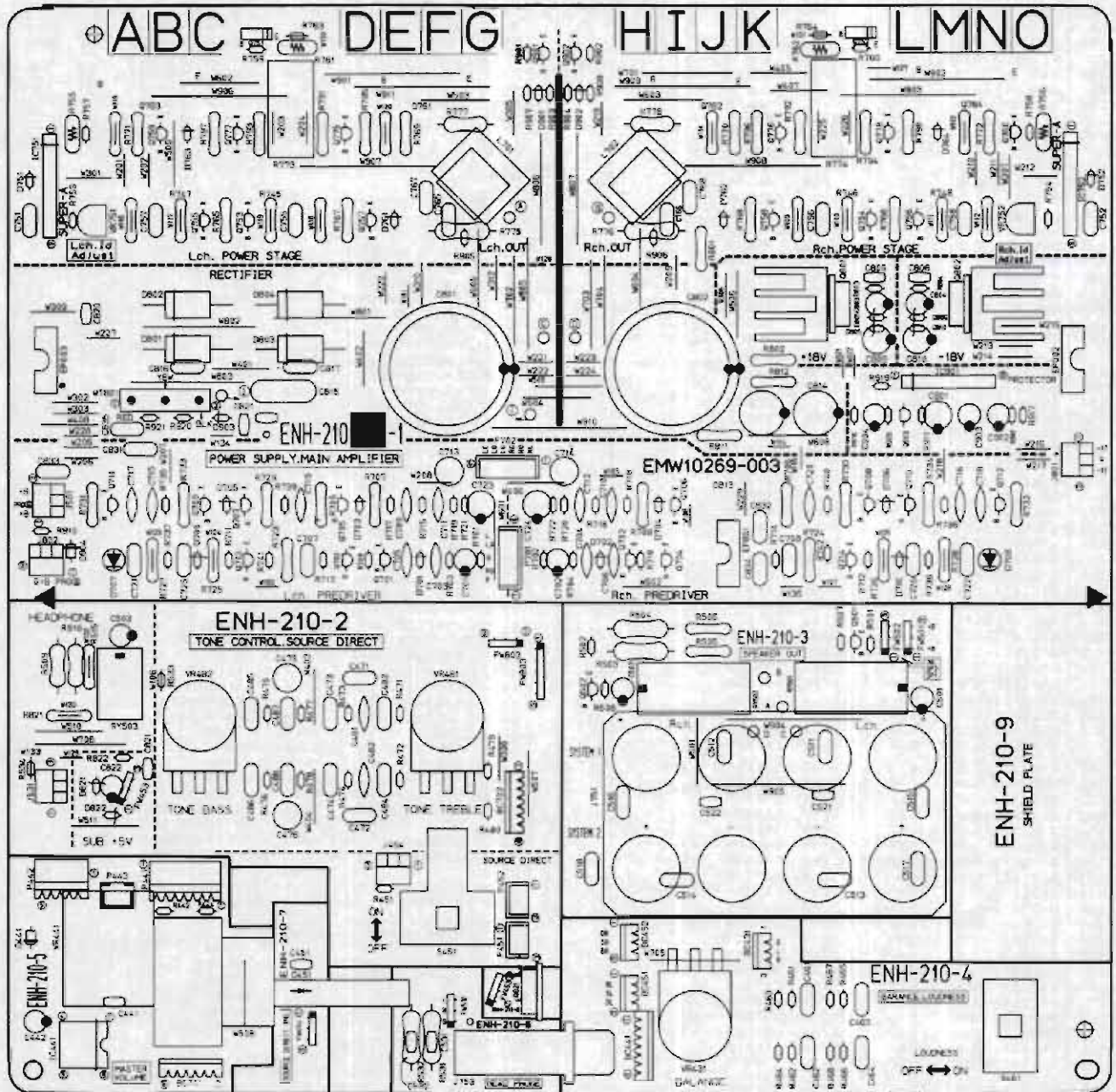

Note (1)

PC Board Ass'y	Designated Areas
ENH-210 <input type="checkbox"/>	Continental Europe, Scandinavia
ENH-210 <input type="checkbox"/>	Universal Type

Transistors

ITEM	PART NUMBER	DESCRIPTION	AREA
Q501	2SC2240(GR,BL)	SILICON TOSHIBA	
Q502	2SC2240(GR,BL)	SILICON TOSHIBA	
Q701	2SC2240(A,B)	SILICON TOSHIBA	
Q702	2SC2240(A,B)	SILICON TOSHIBA	
Q703	2SC2240(A,B)	SILICON TOSHIBA	
Q704	2SC2240(A,B)	SILICON TOSHIBA	
Q705	2SA933LN(R,S)	SILICON ROHM	
Q706	2SA933LN(R,S)	SILICON ROHM	
Q707	2SA933LN(R,S)	SILICON ROHM	
Q708	2SA933LN(R,S)	SILICON ROHM	
Q709	2SA1207(S,T)	SILICON SANYO	
Q710	2SA1207(S,T)	SILICON SANYO	
Q711	2SC2909(S,T)	SILICON SANYO	
Q712	2SC2909(S,T)	SILICON SANYO	
Q713	2SC3311A(Q,R)	SILICON MATSUSHITA	
Q714	2SC3311A(Q,R)	SILICON MATSUSHITA	
Q751	2SD637(Q,R)	SILICON MATSUSHITA	
Q752	2SD637(Q,R)	SILICON MATSUSHITA	
Q753	2SC2240(GR,BL)	SILICON TOSHIBA	
Q754	2SC2240(GR,BL)	SILICON TOSHIBA	
Q755	2SA970(GR,BL)	SILICON TOSHIBA	
Q756	2SA970(GR,BL)	SILICON TOSHIBA	
Q757	PT141	SILICON	
Q757	2SC2235(O,Y)	SILICON TOSHIBA	
Q758	2SC2235(O,Y)	SILICON TOSHIBA	
Q759	2SA965(O,Y)	SILICON 0062	
Q760	2SA965(O,Y)	SILICON 0062	
Q761	PT197	SILICON	
Q761	2SC3854LD(O,Y)	SILICON SANKEN	
Q762	2SC3854LD(O,Y)	SILICON SANKEN	
Q763	2SA1490LD(O,Y)	SILICON SANKEN	
Q764	2SA1490LD(O,Y)	SILICON SANKEN	
Q775	2SC1740(R,S)	SILICON ROHM	
Q776	2SC1740(R,S)	SILICON ROHM	
Q777	2SA933S(R,S)	SILICON ROHM	
Q778	2SA933S(R,S)	SILICON ROHM	
Q801	2SD2061(E,F)	SILICON ROHM	
Q802	2SB1187(E,F)	SILICON ROHM	
Q821	2SD1944(J,K)	SILICON ROHM	
Q901	2SC2389(S,E)	SILICON ROHM	
Q902	2SC2389(S,E)	SILICON ROHM	
Q903	2SA970(GR,BL)	SILICON TOSHIBA	

△ : SAFETY PARTS

I.C.s

ITEM	PART NUMBER	DESCRIPTION	AREA
IC441	LB1639-CV	I.C. SANYO	
IC751	VC5022-2	I.C. SANYO	
IC752	VC5022-2	I.C. SANYO	
IC901	UPC1237HA	I.C. NEC	

△ : SAFETY PARTS

Diodes

ITEM	PART NUMBER	DESCRIPTION	AREA
D441	ERA15-02L19	SILICON KYOUDOU	
D451	SLR-342YCA47	L.E.D.	
D701	1SS119	SILICON HITACHI	
D702	1SS119	SILICON HITACHI	
D703	1SS119	SILICON HITACHI	
D704	1SS119	SILICON HITACHI	
D705	MT22.7JB	ZENER ROHM	
D706	MT22.7JB	ZENER ROHM	
D707	SLR-34VC50F124	L.E.D. ROHM	
D708	SLR-34VC50F124	L.E.D. ROHM	
D709	MT26.2JC	ZENER ROHM	
D710	MT26.2JC	ZENER ROHM	
D751	1SS119	SILICON HITACHI	
D752	1SS119	SILICON HITACHI	
D761	1SS119	SILICON HITACHI	
D762	1SS119	SILICON HITACHI	
D763	1SS119	SILICON HITACHI	
D764	1SS119	SILICON HITACHI	
D801	30DL2FC	SILICON NIHONINTER	
D802	30DL2FC	SILICON NIHONINTER	

△ : SAFETY PARTS

Diodes

ITEM	PART NUMBER	DESCRIPTION	AREA
D803	30DL2FC	SILICON NIHONINTER	
D804	30DL2FC	SILICON NIHONINTER	
D805	RD18JSB3	ZENER NEC	
D806	RD18JSB3	ZENER NEC	
D809	MTZ20JC	ZENER ROHM	
D810	MTZ20JC	ZENER ROHM	
D821	RD6.BJSB1Y	ZENER NEC	
D822	RD6.BJSB3	ZENER NEC	
D901	1SS119	SILICON HITACHI	
D902	1SS119	SILICON HITACHI	
D903	1SS119	SILICON HITACHI	
D904	ERA15-02L19	SILICON KYOUDOU	

△ : SAFETY PARTS

Capacitors

ITEM	PART NUMBER	DESCRIPTION	AREA
C441	QCHB1EZ-223	0.022MF 25V CERAMIC	
C442	QETB1AM-107	100PF 10V ELECTRO	
C451	QCHB1EZ-223	0.022MF 25V CERAMIC	
C461	QFN81HJ-122	1200PF 50V MYLAR	
C462	QFN81HJ-122	1200PF 50V MYLAR	
C463	QFVB1HJ-823N	0.082MF 50V T.FILM	
C464	QFVB1HJ-823N	0.082MF 50V T.FILM	
C471	QFN81HJ-332	3300PF 50V MYLAR	
C472	QFN81HJ-332	3300PF 50V MYLAR	
C473	QFVB1HJ-183N	0.018MF 50V T.FILM	
C474	QFVB1HJ-183N	0.018MF 50V T.FILM	
C475	QEN51HM-475	4.7MF 50V NON POLE	
C476	QEN51HM-475	4.7MF 50V NON POLE	
C481	QCS21HJ-221	220PF 50V CERAMIC	
C482	QCS21HJ-221	220PF 50V CERAMIC	
C483	QFN81HJ-122	1200PF 50V MYLAR	
C484	QFN81HJ-122	1200PF 50V MYLAR	
C485	QFVB1HJ-153N	0.015MF 50V T.FILM	
C486	QFVB1HJ-153N	0.015MF 50V T.FILM	
C487	QFVB1HJ-823N	0.082MF 50V T.FILM	
C488	QFVB1HJ-823N	0.082MF 50V T.FILM	
C501	EETB1HM-105E	1MF 50V ELECTRO	
C502	EETB1HM-105E	1MF 50V ELECTRO	
C503	EETB1HM-105E	1MF 50V ELECTRO	
C701	EETB1HM-475E	4.7MF 50V ELECTRO	
C702	EETB1HM-475E	4.7MF 50V ELECTRO	
C703	QCS21HJ-101	100PF 50V CERAMIC	
C704	QCS21HJ-101	100PF 50V CERAMIC	
C705	QCS21HJ-101	100PF 50V CERAMIC	
C706	QCS21HJ-101	100PF 50V CERAMIC	
C707	QFN31HJ-821Z	820PF 50V MYLAR	
C708	QFN31HJ-821Z	820PF 50V MYLAR	
C709	QCS21HJ-220	22PF 50V CERAMIC	
C710	QCS21HJ-220	22PF 50V CERAMIC	
C711	QCS21HJ-220	22PF 50V CERAMIC	
C712	QCS21HJ-220	22PF 50V CERAMIC	
C713	QEN51HM-475	4.7MF 50V NON POLE	
C714	QEN51HM-475	4.7MF 50V NON POLE	
C715	QCS21HJ-680	68PF 50V CERAMIC	
C716	QCS21HJ-680	68PF 50V CERAMIC	
C717	QCS21HJ-680	68PF 50V CERAMIC	
C718	QCS21HJ-680	68PF 50V CERAMIC	
C719	QCS21HJ-220	22PF 50V CERAMIC	
C720	QCS21HJ-220	22PF 50V CERAMIC	
C723	EETB1AM-227E	220MF 10V ELECTRO	
C724	EETB1AM-227E	220MF 10V ELECTRO	
C751	QFVB1HJ-103N	0.01MF 50V T.FILM	
C752	QFVB1HJ-103N	0.01MF 50V T.FILM	
C755	QCS22HJ-680A	68PF 500V CERAMIC	
C756	QCS22HJ-680A	68PF 500V CERAMIC	
C757	QCS22HJ-680A	68PF 500V CERAMIC	
C758	QCS22HJ-680A	68PF 500V CERAMIC	
C765	QFVB1HJ-104N	0.1MF 50V T.FILM	
C766	QFVB1HJ-104N	0.1MF 50V T.FILM	
C767	QFVB1HJ-104N	0.1MF 50V T.FILM	
C768	QFVB1HJ-104N	0.1MF 50V T.FILM	
C801	EEW5608-878E	8700MF ELECTRO	
C802	EEW5608-878E	8700MF ELECTRO	
C803	EETB1EM-476E	47MF 25V ELECTRO	
C804	EETB1EM-476E	47MF 25V ELECTRO	
C805	QCGB1HK-102	1000PF 50V CERAMIC	
C806	QCGB1HK-102	1000PF 50V CERAMIC	
C813	EETB1HM-227	220MF 50V ELECTRO	C
C813	EETB1JM-227E	220MF 63V ELECTRO	D
C814	EETB1HM-227	220MF 50V ELECTRO	C
C814	EETB1JM-227E	220MF 63V ELECTRO	D
C815	EFH42EK-104	0.1MF 250V M.MYLAR	
C816	QFN82AJ-104	0.1MF 100V MYLAR	
C817	QFN82AJ-104	0.1MF 100V MYLAR	
C820	QCHB1EZ-223	0.022MF 25V CERAMIC	
C822	QETB1AM-476	47MF 10V ELECTRO	
C901	QETB1AM-227	220MF 10V ELECTRO	
C902	QETB1CM-226	22MF 16V ELECTRO	
C903	QETB1HM-475	4.7MF 50V ELECTRO	
C904	QETB1HM-226	22MF 50V ELECTRO	

△ : SAFETY PARTS

Resistors

ITEM	PART NUMBER	DESCRIPTION	AREA
R443	QRD161J-221	220 1/6W CARBON	
R444	QRD161J-221	220 1/6W CARBON	
R451	QRD167J-181	180 1/6W CARBON	
R461	QRD167J-183	18K 1/6W CARBON	
R462	QRD167J-183	18K 1/6W CARBON	
R463	QRD167J-474	470K 1/6W CARBON	
R464	QRD167J-474	470K 1/6W CARBON	
R465	QRD167J-203	20K 1/6W CARBON	
R466	QRD167J-203	20K 1/6W CARBON	
R467	QRD167J-512	5.1K 1/6W CARBON	
R468	QRD167J-512	5.1K 1/6W CARBON	
R471	QRD167J-472	4.7K 1/6W CARBON	
R472	QRD167J-472	4.7K 1/6W CARBON	
R473	QRD167J-821	820 1/6W CARBON	
R474	QRD167J-821	820 1/6W CARBON	
R475	QRD167J-203	20K 1/6W CARBON	
R476	QRD167J-203	20K 1/6W CARBON	
R477	QRD167J-362	3.6K 1/6W CARBON	
R478	QRD167J-362	3.6K 1/6W CARBON	
R479	QRD167J-474	470K 1/6W CARBON	
R480	QRD167J-474	470K 1/6W CARBON	
R501	QRD167J-222	2.2K 1/6W CARBON	
R502	QRD167J-222	2.2K 1/6W CARBON	
R503	QRG022J-821AM	820 2W O.M. FILM	
R504	QRG022J-821AM	820 2W O.M. FILM	
R505	QRD14CJ-221S	220 1/4W UNF. CARBON	
R506	QRD14CJ-221S	220 1/4W UNF. CARBON	
R509	QRG012J-102A	1K 1W G.M. FILM	
R510	QRG012J-222A	2.2K 1W G.M. FILM	
R551	QRG022J-331A	330 2W O.M. FILM	
R532	QRG022J-331A	330 2W O.M. FILM	
R701	QRD161J-221	220 1/6W CARBON	
R702	QRD161J-221	220 1/6W CARBON	
R703	QRD167J-104	100K 1/6W CARBON	
R704	QRD167J-104	100K 1/6W CARBON	
R705	QRD14CJ-101S	100 1/4W UNF. CARBON	
R706	QRD14CJ-101S	100 1/4W UNF. CARBON	
R707	QRD14CJ-121S	120 1/4W UNF. CARBON	
R708	QRD14CJ-121S	120 1/4W UNF. CARBON	
R709	QRD167J-222	2.2K 1/6W CARBON	
R710	QRD167J-222	2.2K 1/6W CARBON	
R711	QRD167J-272	2.7K 1/6W CARBON	
R712	QRD167J-272	2.7K 1/6W CARBON	
R713	QRD167J-101	100 1/6W CARBON	
R714	QRD167J-101	100 1/6W CARBON	
R715	QRD167J-163	16K 1/6W CARBON	
R716	QRD167J-163	16K 1/6W CARBON	
R717	QRD167J-913	91K 1/6W CARBON	
R718	QRD167J-913	91K 1/6W CARBON	
R719	QRD167J-471	470 1/6W CARBON	
R720	QRD167J-471	470 1/6W CARBON	
R721	QRD167J-511	510 1/6W CARBON	
R722	QRD167J-511	510 1/6W CARBON	
R723	QRD14CJ-332S	3.3K 1/4W UNF. CARBON	
R724	QRD14CJ-332S	3.3K 1/4W UNF. CARBON	
R725	QRD14CJ-470S	47 1/4W UNF. CARBON	
R726	QRD14CJ-470S	47 1/4W UNF. CARBON	
R729	QRD14CJ-560S	56 1/4W UNF. CARBON	
R730	QRD14CJ-560S	56 1/4W UNF. CARBON	
R731	QRD14CJ-221S	220 1/4W UNF. CARBON	
R732	QRD14CJ-221S	220 1/4W UNF. CARBON	
R733	QRD14CJ-331S	330 1/4W UNF. CARBON	
R734	QRD14CJ-331S	330 1/4W UNF. CARBON	
R735	QRD167J-333	33K 1/6W CARBON	
R736	QRD167J-333	33K 1/6W CARBON	
R737	QRD167J-333	33K 1/6W CARBON	
R738	QRD167J-333	33K 1/6W CARBON	
R739	QRD167J-333	33K 1/6W CARBON	
R740	QRD167J-333	33K 1/6W CARBON	
R741	QRD167J-333	33K 1/6W CARBON	
R742	QRD167J-333	33K 1/6W CARBON	
R745	QRD14CJ-470S	47 1/4W UNF. CARBON	
R746	QRD14CJ-470S	47 1/4W UNF. CARBON	
R747	QRD14CJ-470S	47 1/4W UNF. CARBON	
R748	QRD14CJ-470S	47 1/4W UNF. CARBON	
R753	QRD167J-471	470 1/6W CARBON	
R754	QRD167J-471	470 1/6W CARBON	
R755	ERT-02WFL351S	350 1/4W THERMISTOR	
R756	ERT-02WFL351S	350 1/4W THERMISTOR	
R757	QRD167J-101	100 1/6W CARBON	
R758	QRD167J-101	100 1/6W CARBON	
R759	QRD167J-391	390 1/6W CARBON	
R760	QRD167J-391	390 1/6W CARBON	
R761	ERT-02WHL202S	2K 1/4W THERMISTOR	
R762	ERT-02WHL202S	2K 1/4W THERMISTOR	
R765	QRD14CJ-122S	1.2K 1/4W UNF. CARBON	
R766	QRD14CJ-122S	1.2K 1/4W UNF. CARBON	
R767	QRD14CJ-151S	150 1/4W UNF. CARBON	
R768	QRD14CJ-151S	150 1/4W UNF. CARBON	
R769	QRD14CJ-100S	10 1/4W UNF. CARBON	
R770	QRD14CJ-100S	10 1/4W UNF. CARBON	
R771	QRD14CJ-100S	10 1/4W UNF. CARBON	
R772	QRD14CJ-100S	10 1/4W UNF. CARBON	
R773	ERF032K-R22	0.22 3W CEMENT	
R774	ERF032K-R22	0.22 3W CEMENT	

△ : SAFETY PARTS

Resistors

ITEM	PART NUMBER	DESCRIPTION	AREA
R775	QRG022J-100A	10 2W O.M. FILM	
R776	QRG022J-100A	10 2W O.M. FILM	
R777	QRD125J-100	10 1/2W UNF. CARBON	
R778	QRD125J-100	10 1/2W UNF. CARBON	
R791	QRD14CJ-621S	620 1/4W UNF. CARBON	
R792	QRD14CJ-621S	620 1/4W UNF. CARBON	
R793	QRD14CJ-621S	620 1/4W UNF. CARBON	
R794	QRD14CJ-621S	620 1/4W UNF. CARBON	
R795	QRD14CJ-181S	180 1/4W UNF. CARBON	
R796	QRD14CJ-181S	180 1/4W UNF. CARBON	
R797	QRD14CJ-181S	180 1/4W UNF. CARBON	
R798	QRD14CJ-181S	180 1/4W UNF. CARBON	
R801	QRZ0077-100	10 1/4W FUSIBLE	
R802	QRZ0077-100	10 1/4W FUSIBLE	
R803	QRD167J-123	12K 1/6W CARBON	
R804	QRD167J-123	12K 1/6W CARBON	
R811	QRD14CJ-330S	33 1/4W UNF. CARBON	
R812	QRD14CJ-330S	33 1/4W UNF. CARBON	
R821	QRZ0077-100	10 1/4W FUSIBLE	
R822	QRD167J-223	22K 1/6W CARBON	
R901	QRD167J-272	2.7K 1/6W CARBON	
R902	QRD167J-272	2.7K 1/6W CARBON	
R903	QRD167J-153	15K 1/6W CARBON	
R904	QRD167J-153	15K 1/6W CARBON	
R905	QRD167J-104	100K 1/6W CARBON	
R906	QRD167J-823	82K 1/6W CARBON	
R907	QRD167J-223	22K 1/6W CARBON	
R908	QRD167J-223	22K 1/6W CARBON	
R909	QRD167J-103	10K 1/6W CARBON	
R910	QRD167J-224	220K 1/6W CARBON	
R911	QRD167J-473	47K 1/6W CARBON	
R916	QRD167J-103	10K 1/6W CARBON	
R917	QRD167J-103	10K 1/6W CARBON	
R918	QRD167J-224	220K 1/6W CARBON	
R919	QRD167J-332	3.3K 1/6W CARBON	
R920	QRD167J-273	27K 1/6W CARBON	
R921	QRD167J-822	8.2K 1/6W CARBON	
VR431	QVDB87M-EF5C	250K VARIABLE	
VR441	QVDB94B-E54C	50K VARIABLE	
VR481	QVDB87C-E15E	100K VARIABLE	
VR482	QVDB87C-E15E	100K VARIABLE	
VR51	QVPE601-501	500 0.15W VARIABLE	
VR52	QVPE601-501	500 0.15W VARIABLE	

△ : SAFETY PARTS

Others

△	ITEM	PART NUMBER	DESCRIPTION	AREA
		EMW10269-003		
		EW1011-076	TERMINAL WIRE	
		E305804-001	HOLDER GUIDE	
		E305805-001	HOLDER STAY	
		E308135-003	HEAT SINK	
		E73525-003	SCREW	
		G8S63008CC	SCREW	
		SILICON-GREASE		
		WNS3000CC	WASHER	
J454		EMV7122-103	CONNECTOR3PIN	
J501		EMV7122-103	CONNECTOR3PIN	
J531		EMV7122-103	CONNECTOR3PIN	
J751		EMB00TP-801H	SPEAKER TERMINAL	
J753		QMS6302-131	HEADPHONE JACK	
J801		EMV7122-103	CONNECTOR3PIN	
J802		EMV7122-103	CONNECTOR3PIN	
L701		EQL0001-1R0	INDUCTOR	
L702		EQL0001-1R0	INDUCTOR	
P441		EMV5109-007B	PLUG ASSY7PIN	
P442		EMV5109-005B	PLUG ASSY5PIN	
P443		EMV5103-002B	PLUG ASSY2PIN	
P451		EMV5109-003A	PLUG ASSY3PIN	
P452		EMV5109-003A	PLUG ASSY3PIN	
P701		EMV5109-006A	PLUG ASSY6PIN	
P702		EMV5109-006A	PLUG ASSY6PIN	

△ : SAFETY PARTS

Others

△	ITEM	PART NUMBER	DESCRIPTION	AREA
	S451	QSTL102-E04	PUSH SWITCHSOURCE DIRECT	
	S461	QSTL102-E02	PUSH SWITCHLOUDNESS	
	BC431	EWS293-0116	SOCKET WIRE3PIN	
	BC441	EWS297-2116	SOCKET WIRE7PIN	
	BC451	LWS293-0116	SOCKET WIRE3PIN	
	BC452	EWS293-0116	SOCKET WIRE3PIN	
	BC701	EWS296-1910	SOCKET WIRE6PIN	
	BC702	EWS296-1920	SOCKET WIRE6PIN	
	EP002	E70859-001	EARTH PLATE	
	EP003	E70859-001	EARTH PLATE	
	EP801	E70859-001	EARTH PLATE	
	FW453	EWR338-13SST	FLAT WIRE3PIN	
	FW454	EWR338-08LST	FLAT WIRE3PIN	
	FW501	EWR338-35LST	FLAT WIRE3PIN	
	FW502	EWR338-20LST	FLAT WIRE2PIN	
	FW531	EWR338-08LST	FLAT WIRE3PIN	
	FW802	EWR338-13LST	FLAT WIRE3PIN	
	FW803	EWR358-16LST	FLAT WIRE4PIN	
	RY501	ESK7D24-2120	RELAYSYSTEM-1	
	RY502	ESK7D24-2120	RELAYSYSTEM-2	
	RY503	ESK5D24-21AF	RELAYHEADPHONE	
	WT801	E67764-103	WRAPPING TERMINAL	

△ : SAFETY PARTS

Accessories List

■ Accessories List

△	Part Number	Part Name	Q'ty	Description	Areas
	E30580-1902A	Instruction Book	1		
	E30580-1903A	Instruction Book	1		
	E41202-2	Envelope	1		
	UM-4NJ-2PSA	Battery	1		
△	E04056	Siemens Plug	1		U
	RM-SA561U	Remote Control Unit	1		
	E35497-015	Caution Sheet	1		U

△ : Safety Parts

★ The Marks for Designated Areas

EN Scandinavia
 EF Continental Europe

U Universal Type
 No mark indicates all areas.

Packing Materials and Part Numbers

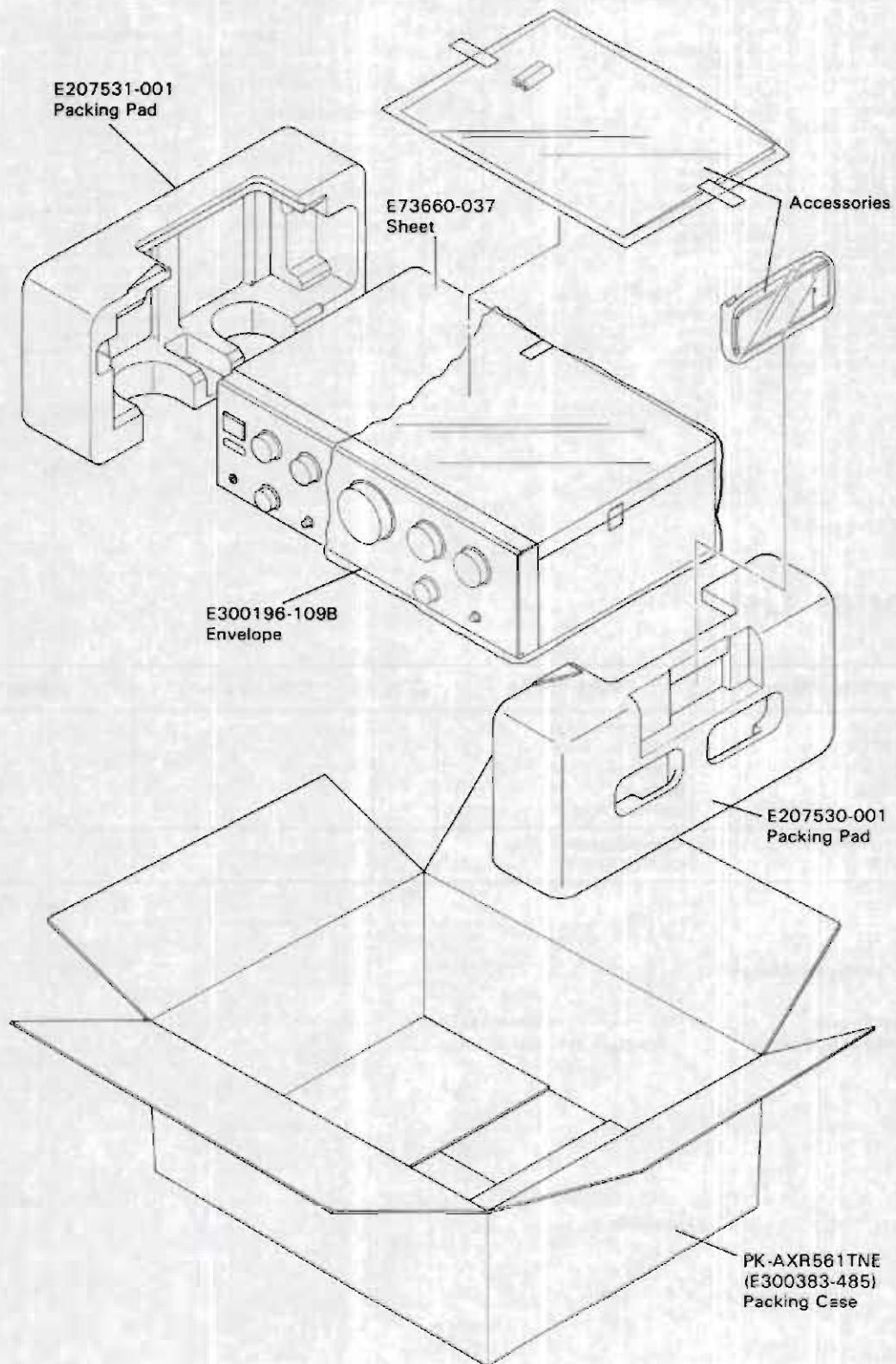

The Marks for Designated Areas

EN	Scandinavia	U	Universal Type
EF	Continental Europe	No mark indicates all areas.	

PARTS LIST

Contents

General Exploded View and Parts List	3-3
Printed Circuit Board Ass'y and Parts List	3-7
■ ENE-084 <input type="checkbox"/> Input & Front PC Board	3-7
■ ENH-210 <input type="checkbox"/> Main Amplifier & Power Supply PC Board	3-10
Accessories List	3-13
Packing Materials and Part Numbers	3-14

PARTS LIST

Contents

1. General Information	1-1
2. Parts List	2-1
3. Assembly Instructions	3-1
4. Troubleshooting	4-1
5. Maintenance	5-1
6. Safety	6-1
7. Warranty	7-1
8. Appendix	8-1

General Exploded View and Parts List

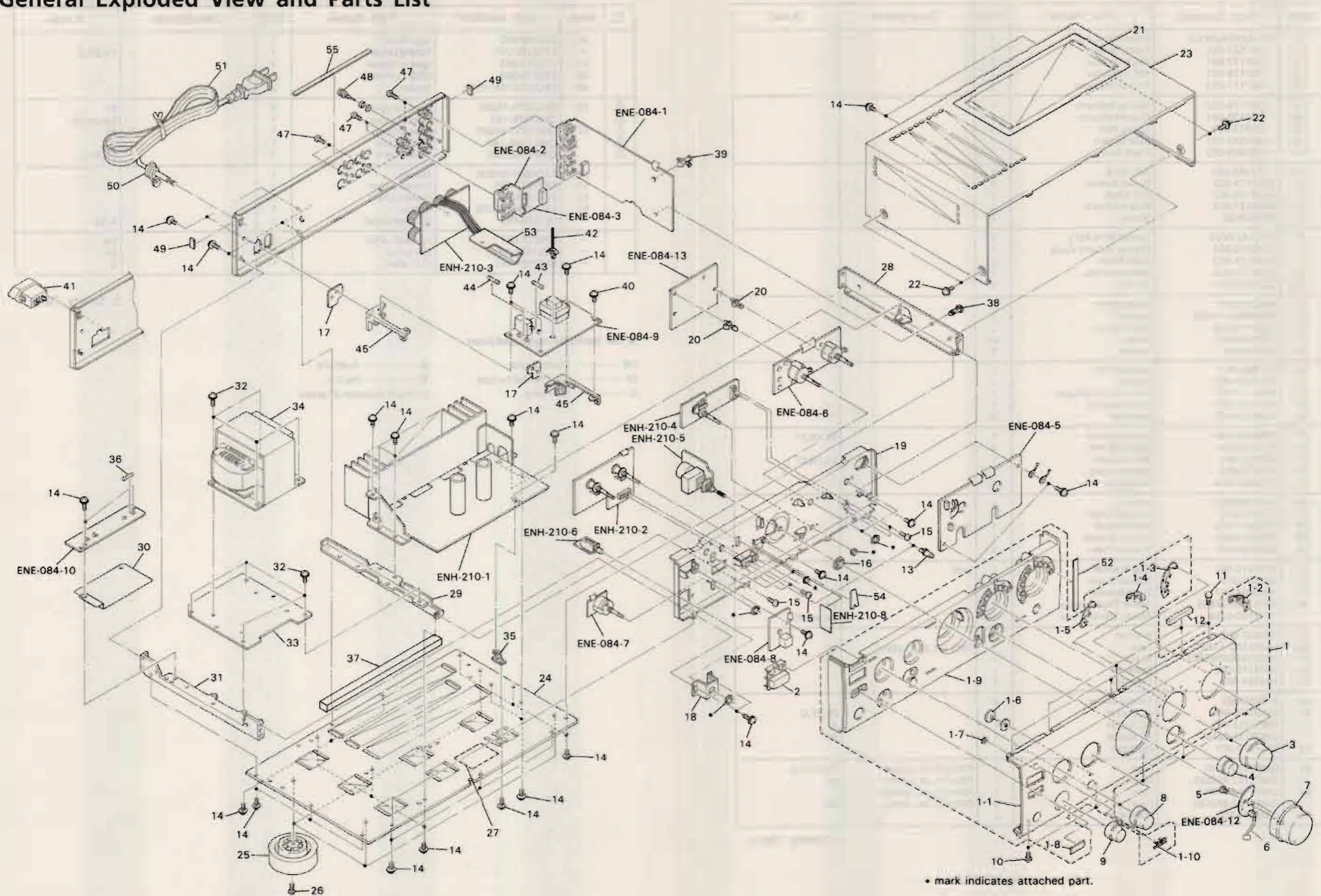

■ Parts List

△	Item	Part Number	Part Name	Q'ty	Description	Areas
	1	EFP-AXR562BKE(S)	Front Panel Ass'y	1		
	1-1	E207527-002	Front Panel	1		
	1-2	E407177-001	REC Indicator	1		
	1-3	E407176-001	REC Indicator	1		
	1-4	E407177-002	Source Indicator	1		
	1-5	E407176-002	Source Indicator	1		
	1-6	E407178-001	Direct Indicator	1		
	1-7	E60912-003	Speed Nut	1		
	1-8	E406592-001	REM Screen	1		
	1-9	E102609-002	Front Base	1		
	1-10	E72968-001	JVC Mark	1		
	2	E407173-002	Power Button	1		
	3	E308139-002	REC Knob	2		
	4	E308137-006	Balance Knob	1		
	5	SDSF2608Z	Screw	1		
	6	EWS142-002B	Socket Wire Ass'y	1		
	7	E308095-004	Master Volume Knob	1		
	8	E308138-002	Tone Knob	2		
	9	E308137-004	Speaker Knob	1		
	10	SDSG3006CC	Screw	5		
	11	E48729-009	Plastic Rivet	3		
	12	EXO060007N40S	Spacer	3		
	13	E407110-002	Push Button	2		
	14	GBSG3008CC	Screw	41		
	15	SBST3008Z	Screw	3		
	16	E71862-001	Volume Nut	1		
	17	E407345-001	Spacer	2		
	18	E407111-001	Head Phone Bracket	1		
	19	E207529-001	Front Bracket	1		
	20	E306232-005	Fastener	2		
	21	E306232-002	Protect Sheet	1		BS,EN,EF
	22	E61660-004	Special Screw	4		
	23	E26753-001	Metal Cover	1		BS,EN,EF
	24	E26273-003	Bottom Cover	1		
	25	E307427-004	Foot Ass'y	4		
	26	GBST3008CC	Screw	4		
	27	E70115-002	Caution Label	1		
	28	E305811-002	Side Bracket	1	Right	
	29	E305812-002	Center Bracket	1		
	30	E406626-001	Protect Sheet	1		
	31	E305810-001	Side Bracket	1	Left	
	32	E61661-005	Special Screw	8		
	33	E305803-007	Trans Bracket	1		
△	34	ETP1100-32EBBS	Power Transformer	1		BS
△	34	ETP1100-32EB	Power Transformer	1		Except BS
△	35	E68587-008	Bracket	1		
△	36	QMF51A2-1R25S	Fuse	1	F003 (T1.25A / 250V)	EF
△	37	EX0255005N60S02	Spacer	1		
△	38	E303216-006	Fastener	1		
△	39	E69384-002	Fastener	1		
△	40	E74266-002	Special Screw	2		
△	41	EMC0236-001	AC Socket	1		EN,EF,G
△		EMC0233-001	AC Socket	1		A
△		EMC0237-001BS	AC Socket	1		BS
△	42	E307572-001	Fastener	1		
△	43	QMF51A2-R10S	Fuse	1	F002 (T0.1A / 250V)	EN,EF,G,A
△		QMF51E2-R10SBS	Fuse	1	F002 (T0.1A / 250V)	BS
△	44	QMF51A2-2R0S	Fuse	1	F001 (T2.0A / 250V)	
△		QMF51E2-2R0SBS	Fuse	2	F001 (T2.0A / 250V)	BS
△	45	E406074-001	Bracket	2		

△ Safety Parts

△	Item	Part Number	Part Name	Q'ty	Description	Areas
	46	E26740-038	Rear Panel	1		
	-	E303260-241	Rating Label	1		EN,EF,G
	47	E73273-003	Special Screw	7		
	48	E70078-003	GND Terminal	1		
	49	EXO020010R10S10	Spacer	2		
△	50	QHS3876-162BS	Cord Stopper	1		BS
△		QHS3876-162	Cord Stopper	1		Except BS
△	51	QMP9017-008BS	Power Cord	1		BS
△		QMP2560-244	Power Cord	1		A
△		QMP3900-200	Power Cord	1		EN,EF,G
	52	EXO060010H03S	Spacer	1		
	53	E407327-001	Protect Cover	1		
	53	E407344-001	Protect Sheet	1		
	54	EXO150010N20S	Spacer	1		
	-	E61029-005	Number Label	1		A,BS
	-	E70027-001	Approval Label	1		EN
	-	QZL1031-101	SEV Label	1		EF
	-	E407091-063	FTZ Label	1		G

△ Safety Parts

★ The Marks for Designated Areas

EN Scandinavia

A Australia

EF Continental Europe

BS the U.K.

G Germany

No mark indicates all areas.

Printed Circuit Board Ass'y and Parts List

■ENE-084 □ Input & Front PC Board

Note : ENE-084 □ varies according to the areas employed. See note (1) when placing an order.

※ All printed circuit board assemblies are not available as service parts.

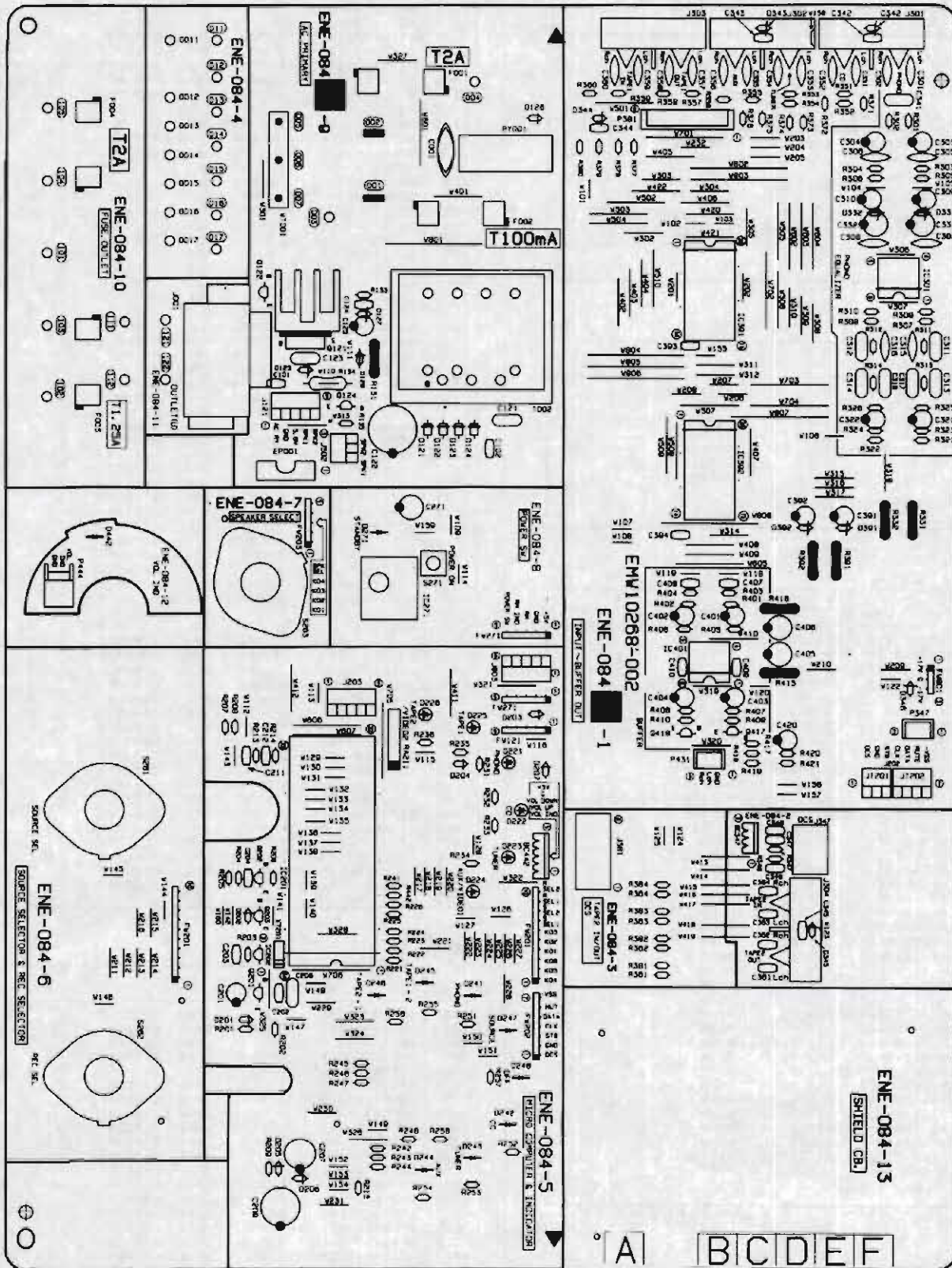

Note (1)

PC Board Ass'y	Designated Areas
ENE-084 D BS	the U.K.
ENE-084 E	Australia
ENE-084 B	Scandinavia
ENE-084 F	Continental Europe
ENE-084 A	Germany

Transistors

ITEM	PART NUMBER	DESCRIPTION	AREA
Q122	25C2235(O,Y)	SILICON TOSHIBA	
Q124	25C2060(O,R)	SILICON ROHM	
Q201	DTC114YS	SILICON ROHM	
Q202	25C1740S(R,S)	SILICON ROHM	
Q203	DTA124ES	SILICON CO21	
Q417	25C2878(A,B)	SILICON TOSHIBA	
Q418	25C2878(A,B)	SILICON TOSHIBA	

I.C.s

ITEM	PART NUMBER	DESCRIPTION	AREA
IC201	MN171202JPP	I.C. MATSUSHITA	
IC202	PS77046TO	I.C. MITSUMI	
IC271	GP1U501X	I.C. SHARP	
IC301	VC4580DD	I.C. DAINICHI	
IC391	TC9163N	I.C. TOSHIBA	
IC392	TC9164N	I.C. TOSHIBA	
IC401	VC4580D	I.C. DAINICHI	

Diodes

ITEM	PART NUMBER	DESCRIPTION	AREA
D121	ERA15-02L19	SILICON KYOUDOU	
D122	ERA15-02L19	SILICON KYOUDOU	
D123	ERA15-02L19	SILICON KYOUDOU	
D124	ERA15-02L19	SILICON KYOUDOU	
D126	MTZ121C	ZENER ROHM	
D127	RD6.2JSB3	ZENER NEC	
D128	1SS119	SILICON HITACHI	DBS
D128	1SS119	SILICON HITACHI	E
D201	1SS119	SILICON HITACHI	
D202	1SS119	SILICON HITACHI	
D203	1SS119	SILICON HITACHI	
D204	1SS119	SILICON HITACHI	
D205	1SS119	SILICON HITACHI	
D207	1SS119	SILICON HITACHI	
D221	SLR-34DC3F	L.E.D. ROHM	
D222	SLR-34DC3F	L.E.D. ROHM	
D223	SLR-34DC3F	L.E.D. ROHM	
D224	SLR-34DC3F	L.E.D. ROHM	
D225	SLR-34DC3F	L.E.D. ROHM	
D226	SLR-34DC3F	L.E.D. ROHM	
D241	SLR-342VCA47	L.E.D. ROHM	
D242	SLR-342VCA47	L.E.D. ROHM	
D243	SLR-342VCA47	L.E.D. ROHM	
D244	SLR-342VCA47	L.E.D. ROHM	
D245	SLR-342VCA47	L.E.D. ROHM	
D246	SLR-342VCA47	L.E.D. ROHM	
D247	SLR-342VCA47	L.E.D. ROHM	
D248	SLR-342VCA47	L.E.D. ROHM	
D271	SLR-342VCA47	L.E.D. ROHM	A
D271	SLR-342VCA47	L.E.D. ROHM	B
D271	SLA-580LT3F	L.E.D. ROHM	DBS
D271	SLR-342VCA47	L.E.D. ROHM	E
D271	SLR-342VCA47	L.E.D. ROHM	F
D342	MTZ3.3JB	ZENER ROHM	
D345	MTZ3.3JB	ZENER ROHM	
D346	MTZ3.3JB	ZENER ROHM	
D348	1SS119	SILICON HITACHI	
D442	SLR-342VCA47	L.E.D. ROHM	

Δ : SAFETY PARTS

Capacitors

ITEM	PART NUMBER	DESCRIPTION	AREA
C001	QCZ9050-103A	0.01MF CERAMIC	A
C001	QCZ9050-103A	0.01MF CERAMIC	B
C001	QCZ9050-103ABS	0.01MF CERAMIC	DBS
C001	QCZ9050-103A	0.01MF CERAMIC	E
C001	QCZ9050-103A	0.01MF CERAMIC	F
C101	QCXB1Z-223	0.022MF 25V CERAMIC	
C121	QFN81HJ-473	0.047MF 50V MYLAR	
C122	QETB1EM-477	470MF 25V ELECTRO	
C124	QCVB1CM-103	0.01MF 16V CERAMIC	
C129	QETB1CM-474	47MF 16V ELECTRO	
C201	QETB1HM-225	2.2MF 50V ELECTRO	
C202	QCVB1CM-103	0.01MF 16V CERAMIC	
C203	QCVB1CM-103	0.01MF 16V CERAMIC	
C204	QCGB1HK-102	1000PF 50V CERAMIC	
C207	QETB0JM-477	470MF 6.3V ELECTRO	
C208	QCZ0205-155	1.5MF 25V CERAMIC	
C209	QETB0JM-108	1000MF 6.3V ELECTRO	
C211	QCVB1CM-103	0.01MF 16V CERAMIC	
C212	QCVB1CM-103	0.01MF 16V CERAMIC	
C271	QER50JM-107	100MF 6.3V ELECTRO	
C301	QCS21HJ-101	100PF 50V CERAMIC	A
C302	QCS21HJ-101	100PF 50V CERAMIC	A
C303	EETB1HM-106E	10MF 50V ELECTRO	
C304	EETB1HM-106E	10MF 50V ELECTRO	
C305	QCS21HJ-101	100PF 50V CERAMIC	A
C306	QCS21HJ-101	100PF 50V CERAMIC	A
C307	QCS21HJ-101	100PF 50V CERAMIC	
C308	QCS21HJ-101	100PF 50V CERAMIC	
C309	EETB0JM-107E	100MF 6.3V ELECTRO	
C310	EETB0JM-107E	100MF 6.3V ELECTRO	
C311	QFN81HJ-472	4700PF 50V MYLAR	
C312	QFN81HJ-472	4700PF 50V MYLAR	
C313	QFVB1HJ-153N	0.015MF 50V T.FILM	
C314	QFVB1HJ-153N	0.015MF 50V T.FILM	
C315	QCS21HJ-331	330PF 50V CERAMIC	
C316	QCS21HJ-331	330PF 50V CERAMIC	
C317	QFN81HJ-272	2700PF 50V MYLAR	
C318	QFN81HJ-272	2700PF 50V MYLAR	
C321	EETB1HM-106E	10MF 50V ELECTRO	
C322	EETB1HM-106E	10MF 50V ELECTRO	
C331	EETB1CM-107E	100MF 16V ELECTRO	
C332	EETB1CM-107E	100MF 16V ELECTRO	
C341	QFVB1HJ-103N	0.01MF 50V T.FILM	
C347	QCGB1HK-221	220PF 50V CERAMIC	
C349	QCGB1HK-102	1000PF 50V CERAMIC	
C351	QCS21HJ-101	100PF 50V CERAMIC	A
C352	QCS21HJ-101	100PF 50V CERAMIC	A
C353	QCS21HJ-101	100PF 50V CERAMIC	A
C354	QCS21HJ-101	100PF 50V CERAMIC	A
C355	QCS21HJ-101	100PF 50V CERAMIC	A
C356	QCS21HJ-101	100PF 50V CERAMIC	A
C357	QCS21HJ-101	100PF 50V CERAMIC	A
C358	QCS21HJ-101	100PF 50V CERAMIC	A
C359	QCS21HJ-101	100PF 50V CERAMIC	A
C360	QCS21HJ-101	100PF 50V CERAMIC	A
C361	QCGB1HK-101	100PF 50V CERAMIC	A
C362	QCGB1HK-101	100PF 50V CERAMIC	A
C363	QCGB1HK-101	100PF 50V CERAMIC	A
C364	QCGB1HK-101	100PF 50V CERAMIC	A
C391	EETB1EM-476E	47MF 25V ELECTRO	
C392	EETB1EM-476E	47MF 25V ELECTRO	
C393	QCGB1HK-221	220PF 50V CERAMIC	
C394	QCGB1HK-221	220PF 50V CERAMIC	
C401	EETB1HM-106E	10MF 50V ELECTRO	
C402	EETB1HM-106E	10MF 50V ELECTRO	
C403	EETB1HM-106E	10MF 50V ELECTRO	
C404	EETB1HM-106E	10MF 50V ELECTRO	
C405	EETB1EM-476E	47MF 25V ELECTRO	
C406	EETB1EM-476E	47MF 25V ELECTRO	
C420	EETB1HM-105E	1MF 50V ELECTRO	

Δ : SAFETY PARTS

Resistors

ITEM	PART NUMBER	DESCRIPTION	AREA
R131	QR20077-120	12 1/4W FUSIBLE	
R133	QRD167J-152	1.5K 1/6W CARBON	
R135	QRD167J-102	1K 1/6W CARBON	
R201	QRD167J-104	100K 1/6W CARBON	
R202	QRD167J-103	10K 1/6W CARBON	
R203	QRD167J-102	1K 1/6W CARBON	
R204	QRD167J-223	22K 1/6W CARBON	
R205	QRD167J-473	47K 1/6W CARBON	
R206	QRD167J-473	47K 1/6W CARBON	
R207	QRD167J-331	330 1/6W CARBON	
R208	QRD167J-331	330 1/6W CARBON	
R209	QRD161J-221	220 1/6W CARBON	
R213	QRD167J-103	10K 1/6W CARBON	
R214	QRD167J-103	10K 1/6W CARBON	
R215	QRD167J-102	1K 1/6W CARBON	
R221	QRD161J-221	220 1/6W CARBON	
R222	QRD161J-221	220 1/6W CARBON	
R223	QRD161J-221	220 1/6W CARBON	
R224	QRD161J-221	220 1/6W CARBON	
R225	QRD161J-221	220 1/6W CARBON	

Resistors

ITEM	PART NUMBER	DESCRIPTION	AREA
R226	QRD161J-221	220 1/6W CARBON	
R241	QRD167J-331	330 1/6W CARBON	
R242	QRD167J-331	330 1/6W CARBON	
R243	QRD167J-331	330 1/6W CARBON	
R244	QRD167J-331	330 1/6W CARBON	
R245	QRD167J-331	330 1/6W CARBON	
R246	QRD167J-331	330 1/6W CARBON	
R247	QRD167J-331	330 1/6W CARBON	
R248	QRD167J-331	330 1/6W CARBON	
R301	QRD167J-222	2.2K 1/6W CARBON	
R302	QRD167J-222	2.2K 1/6W CARBON	
R303	QRD167J-473	47K 1/6W CARBON	
R304	QRD167J-473	47K 1/6W CARBON	
R305	QRD167J-241	240 1/6W CARBON	
R306	QRD167J-241	240 1/6W CARBON	
R307	QRD167J-125	1.2M 1/6W CARBON	
R308	QRD167J-125	1.2M 1/6W CARBON	
R309	QRD167J-125	1.2M 1/6W CARBON	
R310	QRD167J-125	1.2M 1/6W CARBON	
R311	QRD167J-153	15K 1/6W CARBON	
R312	QRD167J-153	15K 1/6W CARBON	
R313	QRD167J-204	200K 1/6W CARBON	
R314	QRD167J-204	200K 1/6W CARBON	
R321	QRD167J-471	470 1/6W CARBON	
R322	QRD167J-471	470 1/6W CARBON	
R323	QRD167J-104	100K 1/6W CARBON	
R324	QRD167J-104	100K 1/6W CARBON	
R325	QRD167J-104	100K 1/6W CARBON	
R326	QRD167J-104	100K 1/6W CARBON	
R331	QRD14CJ-471S	470 1/4W UNF. CARBON	
R332	QRD14CJ-471S	470 1/4W UNF. CARBON	
R347	QRD161J-221	220 1/6W CARBON	
R348	QRD167J-471	470 1/6W CARBON	
R351	QRD167J-563	56K 1/6W CARBON	
R352	QRD167J-563	56K 1/6W CARBON	
R353	QRD167J-563	56K 1/6W CARBON	
R354	QRD167J-563	56K 1/6W CARBON	
R355	QRD167J-563	56K 1/6W CARBON	
R356	QRD167J-563	56K 1/6W CARBON	
R357	QRD167J-105	1M 1/6W CARBON	
R358	QRD167J-105	1M 1/6W CARBON	
R359	QRD167J-563	56K 1/6W CARBON	
R360	QRD167J-563	56K 1/6W CARBON	
R361	QRD167J-105	1M 1/6W CARBON	
R362	QRD167J-105	1M 1/6W CARBON	
R363	QRD167J-563	56K 1/6W CARBON	
R364	QRD167J-563	56K 1/6W CARBON	
R371	QRD167J-331	330 1/6W CARBON	
R372	QRD167J-331	330 1/6W CARBON	
R373	QRD167J-331	330 1/6W CARBON	
R374	QRD167J-331	330 1/6W CARBON	
R375	QRD167J-331	330 1/6W CARBON	
R376	QRD167J-331	330 1/6W CARBON	
R377	QRD167J-331	330 1/6W CARBON	
R378	QRD167J-331	330 1/6W CARBON	
R379	QRD167J-331	330 1/6W CARBON	
R380	QRD167J-331	330 1/6W CARBON	
R381	QRD167J-331	330 1/6W CARBON	
R382	QRD167J-331	330 1/6W CARBON	
R383	QRD167J-331	330 1/6W CARBON	
R384	QRD167J-331	330 1/6W CARBON	
R391	QRD14CJ-681S	680 1/4W UNF. CARBON	
R392	QRD14CJ-681S	680 1/4W UNF. CARBON	
R401	QRD167J-101	100 1/6W CARBON	
R402	QRD167J-101	100 1/6W CARBON	
R403	QRD167J-474	470K 1/6W CARBON	
R404	QRD167J-474	470K 1/6W CARBON	
R405	QRD167J-474	470K 1/6W CARBON	
R406	QRD167J-474	470K 1/6W CARBON	
R407	QRD167J-104	100K 1/6W CARBON	
R408	QRD167J-104	100K 1/6W CARBON	
R409	QRD167J-471	470 1/6W CARBON	
R410	QRD167J-471	470 1/6W CARBON	
R415	QRD14CJ-471S	470 1/4W UNF. CARBON	
R416	QRD14CJ-471S	470 1/4W UNF. CARBON	
R417	QRD167J-102	1K 1/6W CARBON	
R418	QRD167J-102	1K 1/6W CARBON	
R419	QRD167J-105	1M 1/6W CARBON	
R420	QRD167J-104	100K 1/6W CARBON	
R421	QRD167J-102	1K 1/6W CARBON	
R442	QRD167J-331	330 1/6W CARBON	
R4211	QRD055J-223	22K 1/8W R. NETWORK	

⚠ SAFETY PARTS

Others

ITEM	PART NUMBER	DESCRIPTION	AREA
	EWT031-027	TERMINAL WIRE	
	EMW10268-002		A
	EMW10268-002		B
	EMW10268-002BS		DBS
	EMW10268-002		E
	EMW10268-002		F
001	EMZ4001-001	TAB	
F001	EMG7331-002	FUSE CLIP	
F001	EMG7331-002U	FUSE CLIP	
F002	EMG7331-002	FUSE CLIP	
F002	EMG7331-002U	FUSE CLIP	
F003	EMG7331-002	FUSE CLIP	F
F003	EMG7331-002U	FUSE CLIP	F
J121	EMV7122-005	CONNECTOR5PIN	
J202	EMV7122-004	CONNECTOR7PIN	
J202	EMV7122-103	CONNECTOR	
J203	EMV7122-005	CONNECTOR5PIN	
J301	EMN00TV-406A	4P PIN JACKPHONO, CD	
J302	EMN00TV-404A	4P PIN JACKTUNER, AUX	
J303	EMN00TV-404A	4P PIN JACKTAPE-1 REC/PLAY	
J304	EMN00TV-406A	4P PIN JACKTAPE-2 REC/PLAY	
J347	QMS3533-001	MINI JACKCOMPULINK	
J381	EMV7125-008R	CONNECTOR8PIN	
J502	EMV7122-103	CONNECTOR3PIN	
J803	EMV7122-005	CONNECTOR4PIN	
P381	EMV5125-008	PLUG ASSY8PIN	
P431	EMV5109-003A	PLUG ASSY3PIN	
P444	EMV5103-002B	PLUG ASSY2PIN	
S261	QSR211C-E01	ROTARY SWITCHSOURCE SELECTOR	
S262	QSR211C-E01	ROTARY SWITCHREC SELECTOR	
S263	QSR2001-E01A	ROTARY SWITCHSPEAKER SELECTOR	
S271	ESP0001-018	TACT SWITCHPOWERSW	
T002	ETP1000-41EA	POWER TRANSFORMER	A
T002	ETP1000-41EA	POWER TRANSFORMER	B
T002	ETP1000-41EABS	POWER TRANSFORMER	DBS
T002	ETP1000-41EA	POWER TRANSFORMER	E
T002	ETP1000-41EA	POWER TRANSFORMER	F
W442	EWS265-A416	SOCKET WIRE5PIN	
EP001	E70859-001	EARTH PLATE	
FW121	EWR558-55LST	FLAT WIRE5PIN	
FW201	EWR3AB-13SST	FLAT WIRE10PIN	
FW202	EWR37B-13LST	FLAT WIRE7PIN	
FW203	EWR35B-40LST	FLAT WIRE5PIN	
FW271	EWR35B-25SST	FLAT WIRE5PIN	
FW801	EWR33B-10LST	FLAT WIRE3PIN	
RY001	ESK1012-118J1	RELAY	A
RY001	ESK1012-118J1	RELAY	B
RY001	ESK1012-118J1BS	RELAY	DBS
RY001	ESK1012-118J1	RELAY	E
RY001	ESK1012-118J1	RELAY	F
WT001	E67764-203	WRAPPING TERMINAL	
WT201	ECX0060-000EM	RESONATOR	

⚠ SAFETY PARTS

■ ENH-210 □ Main Amplifier & Power Supply PC Board

Note: ENH-210 □ varies according to the areas employed. See note (1) when placing an order.

※ All printed circuit board assemblies are not available as service parts.

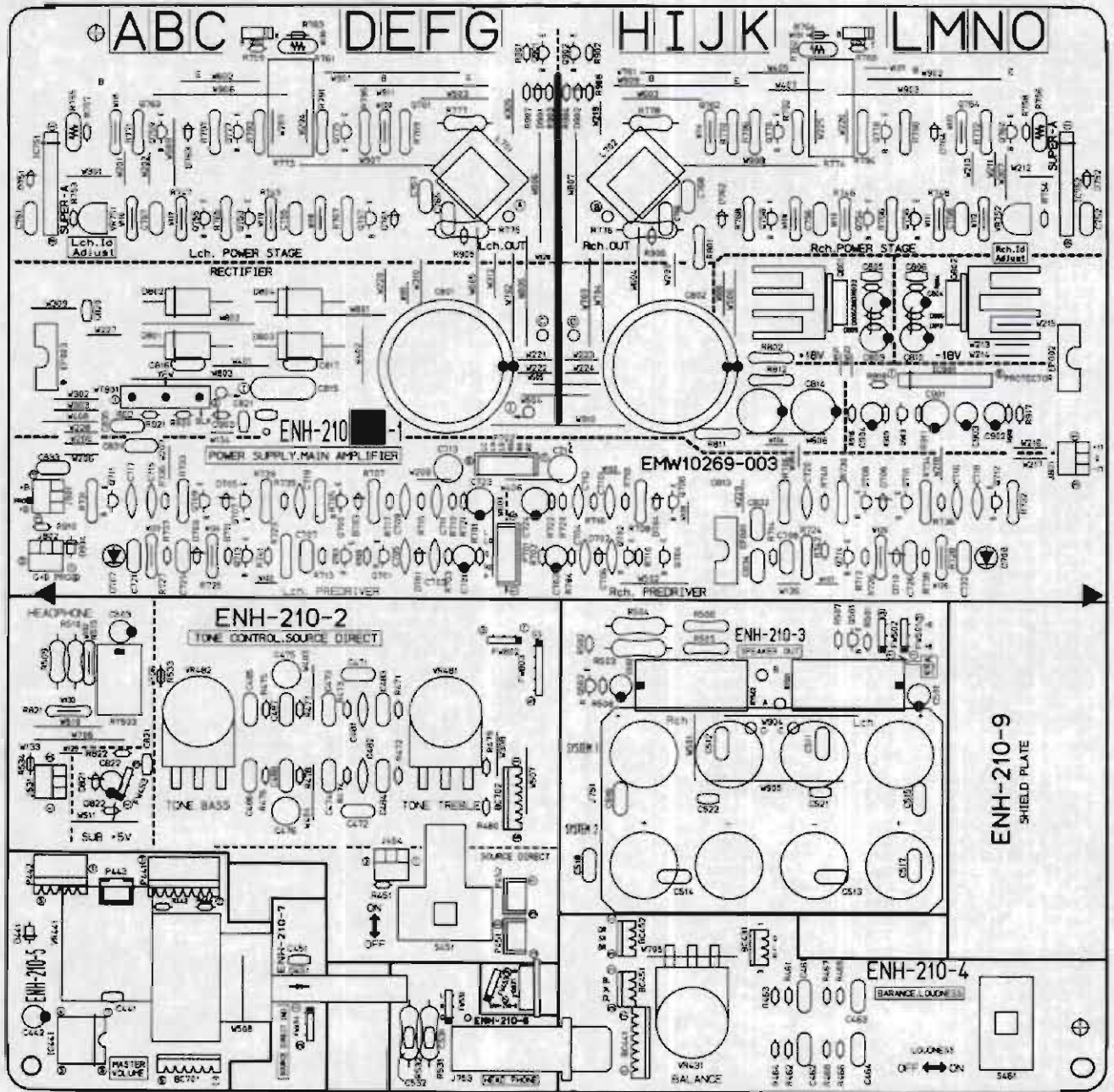

Note (1)

PC Board Ass'y	Designated Areas
ENH-210 B	the U.K. Australia
ENH-210 D	Continental Europe, Scandinavia
ENE-210 A	Germany

Transistors

ITEM	PART NUMBER	DESCRIPTION	AREA
Q501	2SC2240(GR,BL)	SILICON TOSHIBA	
Q502	2SC2240(GR,BL)	SILICON TOSHIBA	
Q701	2SC2240(A,B)	SILICON TOSHIBA	
Q702	2SC2240(A,B)	SILICON TOSHIBA	
Q703	2SC2240(A,B)	SILICON TOSHIBA	
Q704	2SC2240(A,B)	SILICON TOSHIBA	
Q705	2SA933LN(R,S)	SILICON ROHM	
Q706	2SA933LN(R,S)	SILICON ROHM	
Q707	2SA933LN(R,S)	SILICON ROHM	
Q708	2SA933LN(R,S)	SILICON ROHM	
Q709	2SA1207(S,T)	SILICON SANYO	
Q710	2SA1207(S,T)	SILICON SANYO	
Q711	2SC2909(S,T)	SILICON SANYO	
Q712	2SC2909(S,T)	SILICON SANYO	
Q713	2SC3311A(Q,R)	SILICON MATSUSHITA	
Q714	2SC3311A(Q,R)	SILICON MATSUSHITA	
Q751	2SD637(Q,R)	SILICON MATSUSHITA	
Q752	2SD637(Q,R)	SILICON MATSUSHITA	
Q753	2SC2240(GR,BL)	SILICON TOSHIBA	
Q754	2SC2240(GR,BL)	SILICON TOSHIBA	
Q755	2SA970(GR,BL)	SILICON TOSHIBA	
Q756	2SA970(GR,BL)	SILICON TOSHIBA	
Q757	2SC2235(O,Y)	SILICON TOSHIBA	
Q758	2SC2235(O,Y)	SILICON TOSHIBA	
Q759	2SA965(O,Y)	SILICON	
Q760	2SA965(O,Y)	SILICON	
Q761	2SC3854LD(O,Y)	SILICON SANKEN	
Q762	2SC3854LD(O,Y)	SILICON SANKEN	
Q763	2SA1490LD(O,Y)	SILICON SANKEN	
Q764	2SA1490LD(O,Y)	SILICON SANKEN	
Q775	2SC1740(R,S)	SILICON ROHM	
Q776	2SC1740(R,S)	SILICON ROHM	
Q777	2SA933S(R,S)	SILICON ROHM	
Q778	2SA933S(R,S)	SILICON ROHM	
Q801	2SD2061(E,F)	SILICON ROHM	
Q802	2SB1187(E,F)	SILICON ROHM	
Q821	2SD1944(J,K)	SILICON ROHM	
Q901	2SC2389(S,E)	SILICON ROHM	
Q902	2SC2389(S,E)	SILICON ROHM	
Q903	2SA970(GR,BL)	SILICON TOSHIBA	

Diodes

ITEM	PART NUMBER	DESCRIPTION	AREA
D762	1SS119	SILICON HITACHI	
D763	1SS119	SILICON HITACHI	
D764	1SS119	SILICON HITACHI	
D801	30DL2FC	SILICON NIMONINTER	
D802	30DL2FC	SILICON NIMONINTER	
D803	30DL2FC	SILICON NIMONINTER	
D804	30DL2FC	SILICON NIMONINTER	
D805	RD18JSB5	ZENER NEC	
D806	RD18JSB5	ZENER NEC	
D809	MTZ20JC	ZENER RCHM	
D810	MTZ20JC	ZENER RCHM	
D821	RD6.8JSB1	ZENER NEC	
D822	RD6.8JSB5	ZENER NEC	
D901	1SS119	SILICON HITACHI	
D902	1SS119	SILICON HITACHI	
D903	1SS119	SILICON HITACHI	
D904	ERA15-02L19	SILICON KYOUDOU	

△ SAFETY PARTS

Capacitors

ITEM	PART NUMBER	DESCRIPTION	AREA
C441	QCMB1EZ-223	0.022MF 25V CERAMIC	
C442	QETB1AM-107	100MF 10V ELECTRO	
C451	QCMB1EZ-223	0.022MF 25V CERAMIC	
C461	QFN81HJ-122	1200PF 50V MYLAR	
C462	QFN81HJ-122	1200PF 50V MYLAR	
C463	QFVB1HJ-823N	0.082MF 50V T.FILM	
C464	QFVB1HJ-823N	0.082MF 50V T.FILM	
C471	QFN81HJ-332	3300PF 50V MYLAR	
C472	QFN81HJ-332	3300PF 50V MYLAR	
C473	QFVB1HJ-183N	0.018MF 50V T.FILM	
C474	QFVB1HJ-183N	0.018MF 50V T.FILM	
C475	QENS1HM-475	4.7MF 50V NON POLE	
C476	QENS1HM-475	4.7MF 50V NON POLE	
C481	QCS21HJ-221	220PF 50V CERAMIC	
C482	QCS21HJ-221	220PF 50V CERAMIC	
C483	QFN81HJ-122	1200PF 50V MYLAR	
C484	QFN81HJ-122	1200PF 50V MYLAR	
C485	QFVB1HJ-153N	0.015MF 50V T.FILM	
C486	QFVB1HJ-153N	0.015MF 50V T.FILM	
C487	QFVB1HJ-823N	0.082MF 50V T.FILM	
C488	QFVB1HJ-823N	0.082MF 50V T.FILM	
C501	EETB1HM-105E	1MF 50V ELECTRO	
C502	EETB1HM-105E	1MF 50V ELECTRO	
C503	EETB1HM-105E	1MF 50V ELECTRO	
C511	QFVB1HJ-103N	0.01MF 50V T.FILM	A
C512	QFVB1HJ-103N	0.01MF 50V T.FILM	A
C513	QFVB1HJ-103N	0.01MF 50V T.FILM	A
C514	QFVB1HJ-103N	0.01MF 50V T.FILM	A
C521	QCMB1EZ-223	0.022MF 25V CERAMIC	A
C522	QCMB1EZ-223	0.022MF 25V CERAMIC	A
C531	QCGB1HK-102	1000PF 50V CERAMIC	A
C532	QCGB1HK-102	1000PF 50V CERAMIC	A
C701	EETB1HM-475E	4.7MF 50V ELECTRO	
C702	EETB1HM-475E	4.7MF 50V ELECTRO	
C705	QCS21HJ-101	100PF 50V CERAMIC	
C706	QCS21HJ-101	100PF 50V CERAMIC	
C707	QFN31HJ-821Z	820PF 50V MYLAR	
C708	QFN31HJ-821Z	820PF 50V MYLAR	
C709	QCS21HJ-220	22PF 50V CERAMIC	
C710	QCS21HJ-220	22PF 50V CERAMIC	
C711	QCS21HJ-220	22PF 50V CERAMIC	
C712	QCS21HJ-220	22PF 50V CERAMIC	
C713	QENS1HM-475	4.7MF 50V NON POLE	
C714	QENS1HM-475	4.7MF 50V NON POLE	
C715	QCS21HJ-680	68PF 50V CERAMIC	
C716	QCS21HJ-680	68PF 50V CERAMIC	
C717	QCS21HJ-680	68PF 50V CERAMIC	
C718	QCS21HJ-680	68PF 50V CERAMIC	
C719	QCS21HJ-220	22PF 50V CERAMIC	
C720	QCS21HJ-220	22PF 50V CERAMIC	
C723	EETB1AM-227E	220MF 10V ELECTRO	
C724	EETB1AM-227E	220MF 10V ELECTRO	
C751	QFVB1HJ-103N	0.01MF 50V T.FILM	
C752	QFVB1HJ-103N	0.01MF 50V T.FILM	
C755	QCS22HJ-680A	68PF 500V CERAMIC	
C756	QCS22HJ-680A	68PF 500V CERAMIC	
C757	QCS22HJ-680A	68PF 500V CERAMIC	
C758	QCS22HJ-680A	68PF 500V CERAMIC	
C765	QFVB1HJ-104N	0.1MF 50V T.FILM	
C766	QFVB1HJ-104N	0.1MF 50V T.FILM	
C767	QFVB1HJ-104N	0.1MF 50V T.FILM	
C768	QFVB1HJ-104N	0.1MF 50V T.FILM	
C801	EEW5608-878E	8700MF ELECTRO	

I.C.s

ITEM	PART NUMBER	DESCRIPTION	AREA
IC441	LB1639-CV	I.C. SANYO	
IC751	VC5022-2	I.C. SANYO	
IC752	VC5022-2	I.C. SANYO	
IC901	UPC1237HA	I.C. NEC	

Diodes

ITEM	PART NUMBER	DESCRIPTION	AREA
D441	ERA15-02L19	SILICON KYOUDOU	
D451	SLR-342YCA47	L.E.D. ROHM	
D701	1SS119	SILICON HITACHI	
D702	1SS119	SILICON HITACHI	
D703	1SS119	SILICON HITACHI	
D704	1SS119	SILICON HITACHI	
D705	MTZ1.7JB	ZENER ROHM	
D706	MTZ2.7JB	ZENER ROHM	
D707	SLR-34VC50F124	L.E.D. ROHM	
D708	SLR-34VC50F124	L.E.D. ROHM	
D709	MTZ6.2JC	ZENER ROHM	
D710	MTZ6.2JC	ZENER ROHM	
D751	1SS119	SILICON HITACHI	
D752	1SS119	SILICON HITACHI	
D761	1SS119	SILICON HITACHI	

Capacitors

ITEM	PART NUMBER	DESCRIPTION	AREA
C802	EEW5608-87BE	8700MF ELECTRO	
C803	EETB1EM-476E	47MF 25V ELECTRO	
C804	EETB1EM-476E	47MF 25V ELECTRO	
C805	QCGB1HK-102	1000PF 50V CERAMIC	
C806	QCGB1HK-102	1000PF 50V CERAMIC	
C813	EETB1JM-227E	220MF 63V ELECTRO	
C814	EETB1JM-227E	220MF 63V ELECTRO	
C815	QFH42EK-104	0.1MF 250V M.MYLAR	
C816	QFN82AJ-104	0.1MF 100V MYLAR	
C817	QFN82AJ-104	0.1MF 100V MYLAR	
C820	QCHB1E2-223	0.022MF 25V CERAMIC	
C822	QETB1AM-476	47MF 10V ELECTRO	
C901	QETB1AM-227	220MF 10V ELECTRO	
C902	QETB1CM-226	22MF 16V ELECTRO	
C903	QETB1HM-475	4.7MF 50V ELECTRO	
C904	QETB1HM-226	22MF 50V ELECTRO	

Resistors

ITEM	PART NUMBER	DESCRIPTION	AREA
R738	QRD167J-333	33K 1/6W CARBON	
R739	QRD167J-333	33K 1/6W CARBON	
R740	QRD167J-333	33K 1/6W CARBON	
R741	QRD167J-333	33K 1/6W CARBON	
R742	QRD167J-333	33K 1/6W CARBON	
R743	QRD14CJ-470S	47 1/4W UNF. CARBON	
R746	QRD14CJ-470S	47 1/4W UNF. CARBON	
R747	QRD14CJ-470S	47 1/4W UNF. CARBON	
R748	QRD14CJ-470S	47 1/4W UNF. CARBON	
R753	QRD167J-471	470 1/6W CARBON	
R754	QRD167J-471	470 1/6W CARBON	
R755	ERT-D2WFL351S	350 1/4W THERMISTOR	
R756	ERT-D2WFL351S	350 1/4W THERMISTOR	
R757	QRD167J-101	100 1/6W CARBON	
R758	QRD167J-101	100 1/6W CARBON	
R759	QRD167J-391	390 1/6W CARBON	
R760	QRD167J-391	390 1/6W CARBON	
R761	ERT-D2WHL202S	2K 1/4W THERMISTOR	
R762	ERT-D2WHL202S	2K 1/4W THERMISTOR	
R765	QRD14CJ-122S	1.2K 1/4W UNF. CARBON	
R766	QRD14CJ-122S	1.2K 1/4W UNF. CARBON	
R767	QRD14CJ-151S	150 1/4W UNF. CARBON	
R768	QRD14CJ-151S	150 1/4W UNF. CARBON	
R769	QRD14CJ-100S	10 1/4W UNF. CARBON	
R770	QRD14CJ-100S	10 1/4W UNF. CARBON	
R771	QRD14CJ-100S	10 1/4W UNF. CARBON	
R772	QRD14CJ-100S	10 1/4W UNF. CARBON	
R773	ERF032K-R22	0.22 3W CEMENT	
R774	ERF032K-R22	0.22 3W CEMENT	
R775	QRG022J-100A	10 2W O.M.FILM	
R776	QRG022J-100A	10 2W O.M.FILM	
R777	QRD125J-100	10 1/2W UNF. CARBON	
R778	QRD125J-100	10 1/2W UNF. CARBON	
R791	QRD14CJ-621S	620 1/4W UNF. CARBON	
R792	QRD14CJ-621S	620 1/4W UNF. CARBON	
R793	QRD14CJ-621S	620 1/4W UNF. CARBON	
R794	QRD14CJ-621S	620 1/4W UNF. CARBON	
R795	QRD14CJ-181S	180 1/4W UNF. CARBON	
R796	QRD14CJ-181S	180 1/4W UNF. CARBON	
R797	QRD14CJ-181S	180 1/4W UNF. CARBON	
R798	QRD14CJ-181S	180 1/4W UNF. CARBON	
R801	QRZ0077-100	10 1/4W FUSIBLE	
R802	QRZ0077-100	10 1/4W FUSIBLE	
R803	QRD167J-123	12K 1/6W CARBON	
R804	QRD167J-123	12K 1/6W CARBON	
R811	QRD14CJ-330S	33 1/4W UNF. CARBON	
R812	QRD14CJ-330S	33 1/4W UNF. CARBON	
R821	QRZ0077-100	10 1/4W FUSIBLE	
R822	QRD167J-223	22K 1/6W CARBON	
R901	QRD167J-272	2.7K 1/6W CARBON	
R902	QRD167J-272	2.7K 1/6W CARBON	
R903	QRD167J-153	15K 1/6W CARBON	
R904	QRD167J-153	15K 1/6W CARBON	
R905	QRD167J-104	100K 1/6W CARBON	
R906	QRD167J-823	82K 1/6W CARBON	
R907	QRD167J-223	22K 1/6W CARBON	
R908	QRD167J-223	22K 1/6W CARBON	
R909	QRD167J-103	10K 1/6W CARBON	
R910	QRD167J-224	220K 1/6W CARBON	
R911	QRD167J-473	47K 1/6W CARBON	
R916	QRD167J-103	10K 1/6W CARBON	
R917	QRD167J-103	10K 1/6W CARBON	
R918	QRD167J-224	220K 1/6W CARBON	
R919	QRD167J-332	3.3K 1/6W CARBON	
R920	QRD167J-273	27K 1/6W CARBON	
R921	QRD167J-822	8.2K 1/6W CARBON	
VR431	QVDB87M-EF5C	250K VARIABLE	
VR441	QVDB94B-E54C	50K VARIABLE	
VR481	QVDB87C-E15E	100K VARIABLE	
VR482	QVDB87C-E15E	100K VARIABLE	
VR751	QVPE601-501	500 0.15W VARIABLE	
VR752	QVPE601-501	500 0.15W VARIABLE	

△ SAFETY PARTS

Resistors

ITEM	PART NUMBER	DESCRIPTION	AREA
R443	QRD161J-221	220 1/6W CARBON	
R444	QRD161J-221	220 1/6W CARBON	
R451	QRD167J-181	180 1/6W CARBON	
R461	QRD167J-183	18K 1/6W CARBON	
R462	QRD167J-183	18K 1/6W CARBON	
R463	QRD167J-474	470K 1/6W CARBON	
R464	QRD167J-474	470K 1/6W CARBON	
R465	QRD167J-203	20K 1/6W CARBON	
R466	QRD167J-203	20K 1/6W CARBON	
R467	QRD167J-512	5.1K 1/6W CARBON	
R468	QRD167J-512	5.1K 1/6W CARBON	
R471	QRD167J-472	4.7K 1/6W CARBON	
R472	QRD167J-472	4.7K 1/6W CARBON	
R473	QRD167J-821	820 1/6W CARBON	
R474	QRD167J-821	820 1/6W CARBON	
R475	QRD167J-203	20K 1/6W CARBON	
R476	QRD167J-203	20K 1/6W CARBON	
R477	QRD167J-362	3.6K 1/6W CARBON	
R478	QRD167J-362	3.6K 1/6W CARBON	
R479	QRD167J-474	470K 1/6W CARBON	
R480	QRD167J-474	470K 1/6W CARBON	
R501	QRD167J-222	2.2K 1/6W CARBON	
R502	QRD167J-222	2.2K 1/6W CARBON	
R503	QRG022J-B21AM	820 2W O.M.FILM	
R504	QRG022J-B21AM	820 2W O.M.FILM	
R505	QRD14CJ-221S	220 1/4W UNF. CARBON	
R506	QRD14CJ-221S	220 1/4W UNF. CARBON	
R509	QRG012J-102A	1K 1W O.M.FILM	
R510	QRG012J-222A	2.2K 1W O.M.FILM	
R511	QRZ0077-100	10 1/4W FUSIBLE	A
R512	QRZ0077-100	10 1/4W FUSIBLE	A
R513	QRZ0077-100	10 1/4W FUSIBLE	A
R514	QRZ0077-100	10 1/4W FUSIBLE	A
R531	QRG022J-331A	330 2W O.M.FILM	
R532	QRG022J-331A	330 2W O.M.FILM	
R701	QRD161J-221	220 1/6W CARBON	
R702	QRD161J-221	220 1/6W CARBON	
R703	QRD167J-104	100K 1/6W CARBON	
R704	QRD167J-104	100K 1/6W CARBON	
R705	QRD14CJ-101S	100 1/4W UNF. CARBON	
R706	QRD14CJ-101S	100 1/4W UNF. CARBON	
R707	QRD14CJ-121S	120 1/4W UNF. CARBON	
R708	QRD14CJ-121S	120 1/4W UNF. CARBON	
R709	QRD167J-222	2.2K 1/6W CARBON	
R710	QRD167J-222	2.2K 1/6W CARBON	
R711	QRD167J-272	2.7K 1/6W CARBON	
R712	QRD167J-272	2.7K 1/6W CARBON	
R713	QRD167J-101	100 1/6W CARBON	
R714	QRD167J-101	100 1/6W CARBON	
R715	QRD167J-163	16K 1/6W CARBON	
R716	QRD167J-163	16K 1/6W CARBON	
R717	QRD167J-913	91K 1/6W CARBON	
R718	QRD167J-913	91K 1/6W CARBON	
R719	QRD167J-471	470 1/6W CARBON	
R720	QRD167J-471	470 1/6W CARBON	
R721	QRD167J-511	510 1/6W CARBON	
R722	QRD167J-511	510 1/6W CARBON	
R723	QRD14CJ-332S	3.3K 1/4W UNF. CARBON	
R724	QRD14CJ-332S	3.3K 1/4W UNF. CARBON	
R725	QRD14CJ-470S	47 1/4W UNF. CARBON	
R726	QRD14CJ-470S	47 1/4W UNF. CARBON	
R729	QRD14CJ-560S	56 1/4W UNF. CARBON	
R730	QRD14CJ-560S	56 1/4W UNF. CARBON	
R731	QRD14CJ-221S	220 1/4W UNF. CARBON	
R732	QRD14CJ-221S	220 1/4W UNF. CARBON	
R733	QRD14CJ-331S	330 1/4W UNF. CARBON	
R734	QRD14CJ-331S	330 1/4W UNF. CARBON	
R735	QRD167J-333	33K 1/6W CARBON	
R736	QRD167J-333	33K 1/6W CARBON	
R737	QRD167J-333	33K 1/6W CARBON	

Others

ITEM	PART NUMBER	DESCRIPTION	AREA
	EMW10269-003		
	EWT011-076	TERMINAL WIRE	
	E305804-001	HOLDER GUIDE	
	E305805-001	HOLDER STAY	
	E308135-003	HEAT SINK	
	E73525-003	SCREW	
	G8SG3008CC	SCREW	
	SILICON-GREASE		
	WNS3000CC	WASHER	
J454	EMV7122-103	CONNECTOR3PIN	
J501	EMV7122-103	CONNECTOR3PIN	
J531	EMV7122-103	CONNECTOR3PIN	
J751	EMB00TP-801G	SPEAKER TERMINAL	A
J751	EMB00TP-801G	SPEAKER TERMINAL	B
J751	EMB00TP-801H	SPEAKER TERMINAL	D
J753	QMS4302-131	HEADPHONE JACK	
J801	EMV7122-103	CONNECTOR3PIN	
J802	EMV7122-103	CONNECTOR3PIN	
L701	EQL0001-1R0	INDUCTOR	
L702	EQL0001-1R0	INDUCTOR	
P441	EMV5109-007B	PLUG ASSY7PIN	
P442	EMV5109-005B	PLUG ASSY5PIN	
P443	EMV5103-002B	PLUG ASSY2PIN	
P451	EMV5109-003A	PLUG ASSY3PIN	
P452	EMV5109-003A	PLUG ASSY3PIN	

Others

ITEM	PART NUMBER	DESCRIPTION	AREA
P701	EMV5109-006A	PLUG ASSY6PIN	
P702	EMV5109-006A	PLUG ASSY6PIN	
S451	QSTL102-E04	PUSH SWITCHSOURCE DIRECT	
S461	QSTL102-E02	PUSH SWITCHLOUDENESS	
BC431	EWS293-0116	SOCKET WIRE3PIN	
BC441	EWS297-2116	SOCKET WIRE7PIN	
BC451	EWS293-0116	SOCKET WIRE3PIN	
BC452	EWS293-0116	SOCKET WIRE3PIN	
BC701	EWS296-1910	SOCKET WIRE6PIN	
BC702	EWS296-1920	SOCKET WIRE6PIN	
EP002	E70859-001	EARTH PLATE	
EP003	E70859-001	EARTH PLATE	
EP801	E70859-001	EARTH PLATE	
FW453	EWR338-13ST	FLAT WIRE3PIN	
FW454	EWR338-08LST	FLAT WIRE3PIN	
FW501	EWR338-35LST	FLAT WIRE3PIN	
FW502	EWR338-20LST	FLAT WIRE2PIN	
FW531	EWR338-08LST	FLAT WIRE3PIN	
FW802	EWR338-13LST	FLAT WIRE3PIN	
FW803	EWR358-16LST	FLAT WIRE4PIN	
RY501	ESK7024-2120	RELAYSYSYEM-1	
RY502	ESK7024-2120	RELAYSYSYEM-2	
RY503	ESK5024-21AF	RELAYHEADPHONE	
WT801	E67764-103	WRAPPING TERMINAL	

Accessories List

Accessories List

Part Number	Part Name	Q'ty	Description	Areas
E30580-1902A	Instruction Book	1		Except BS
E30580-1902ABS	Instruction Book	1		BS
E30580-1903A	Instruction Book	1		EN
E41202-2	Envelope	1		Except BS
E41202-2B	Envelope	1		BS
BT-20122	NZ Audio Warranty Card	1		A
BT-20134	Warranty Card	1		G
BT20060	Warranty Card	1		BS
BT-20122-1	NZ LTD Sticker	1		A
BT20066A	ECC Agency	1		BS
E43486-340A	Safety Sheet	1		BS
QZL1008-001	FTZ Information Sheet	1		G
UM-4NJ-2PSA	Battery	1		
EMCO202-001BS	AC Plug	1		BS
E43486-371A	Sheet	1		BS
RM-SA562U	Remote Control Unit	1		

 Safety Parts

★ The Marks for Designated Areas

EN Scandinavia

EF Continental Europe

G Germany

A Australia

BS the U.K.

No mark indicates all areas.

Packing Materials and Part Numbers

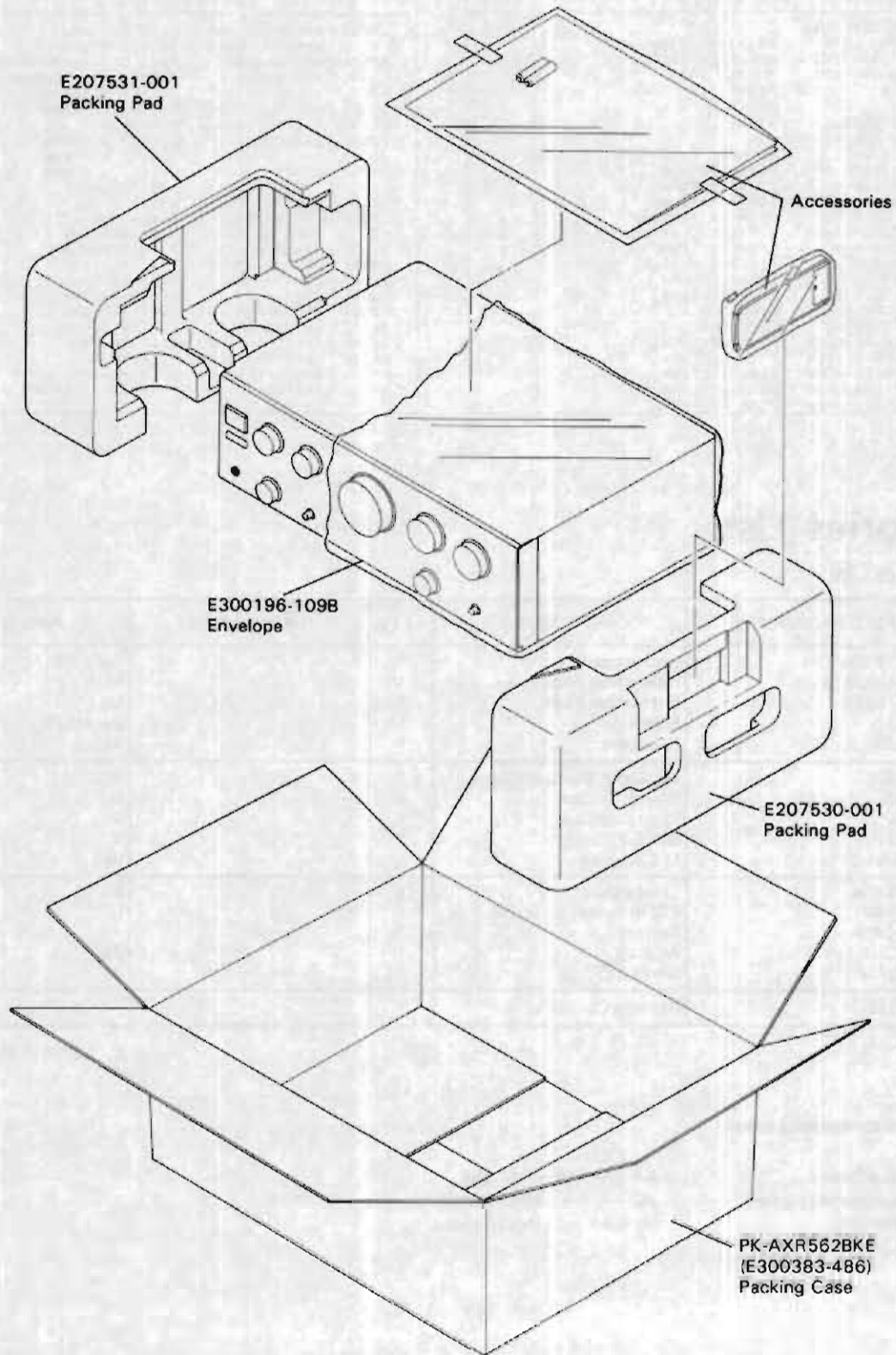

The Marks for Designated Areas

EN	Scandinavia	A	Australia
EF	Continental Europe	BS	the U.K.
G	Germany	No mark indicates all areas.	

Printed Circuit Board

Input & Front PCB (ENE-084)

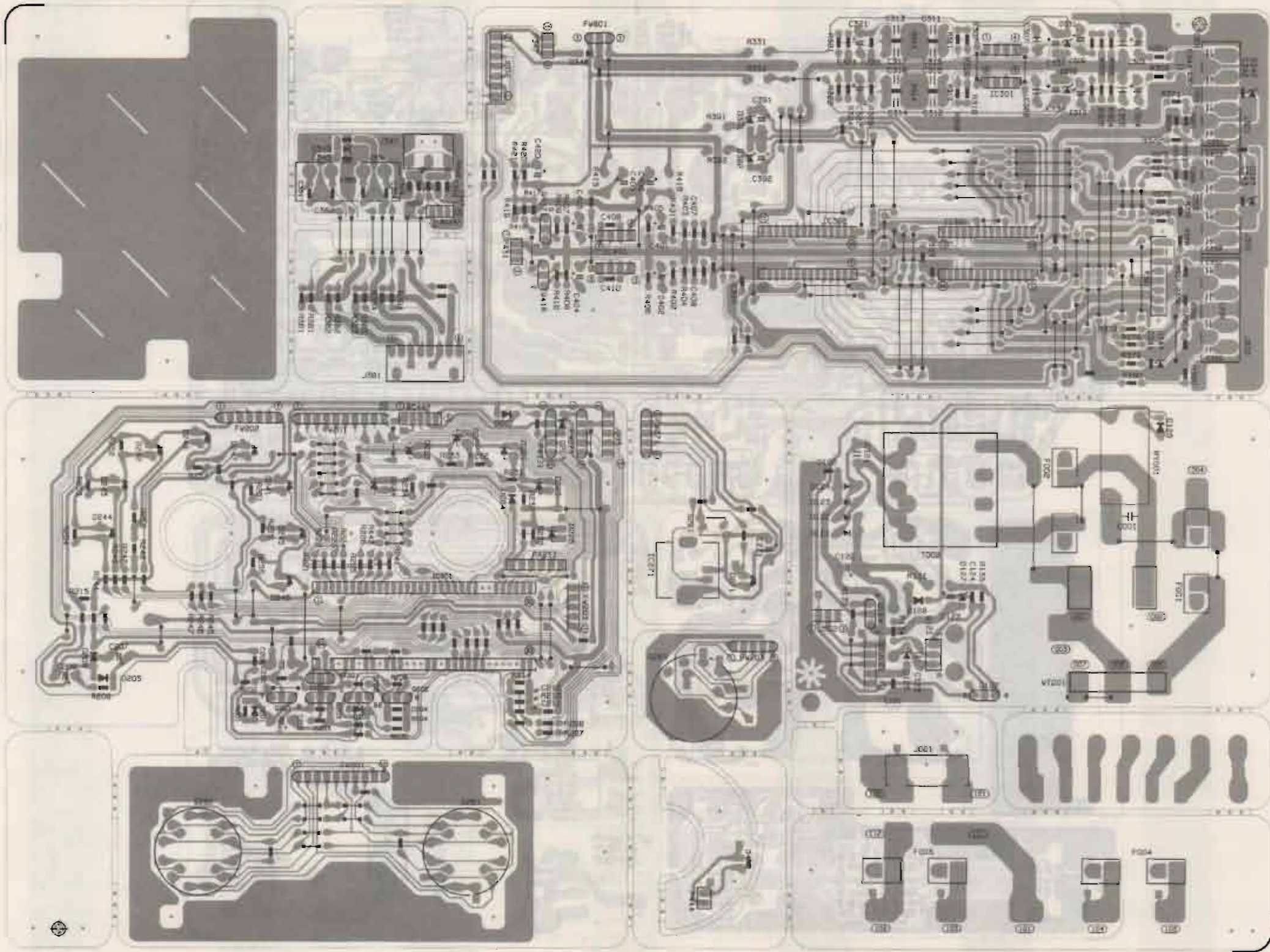

■ Main Amplifier & Power Supply PCB (ENH-210)

Note: This PCB is used for the followings.

- AX-R561TN Continental Europe #12700001 ~ #12700521
Universal Type #12700001 ~ #12700314
- AX-R562BK Continental Europe #12700001 ~ #12700520

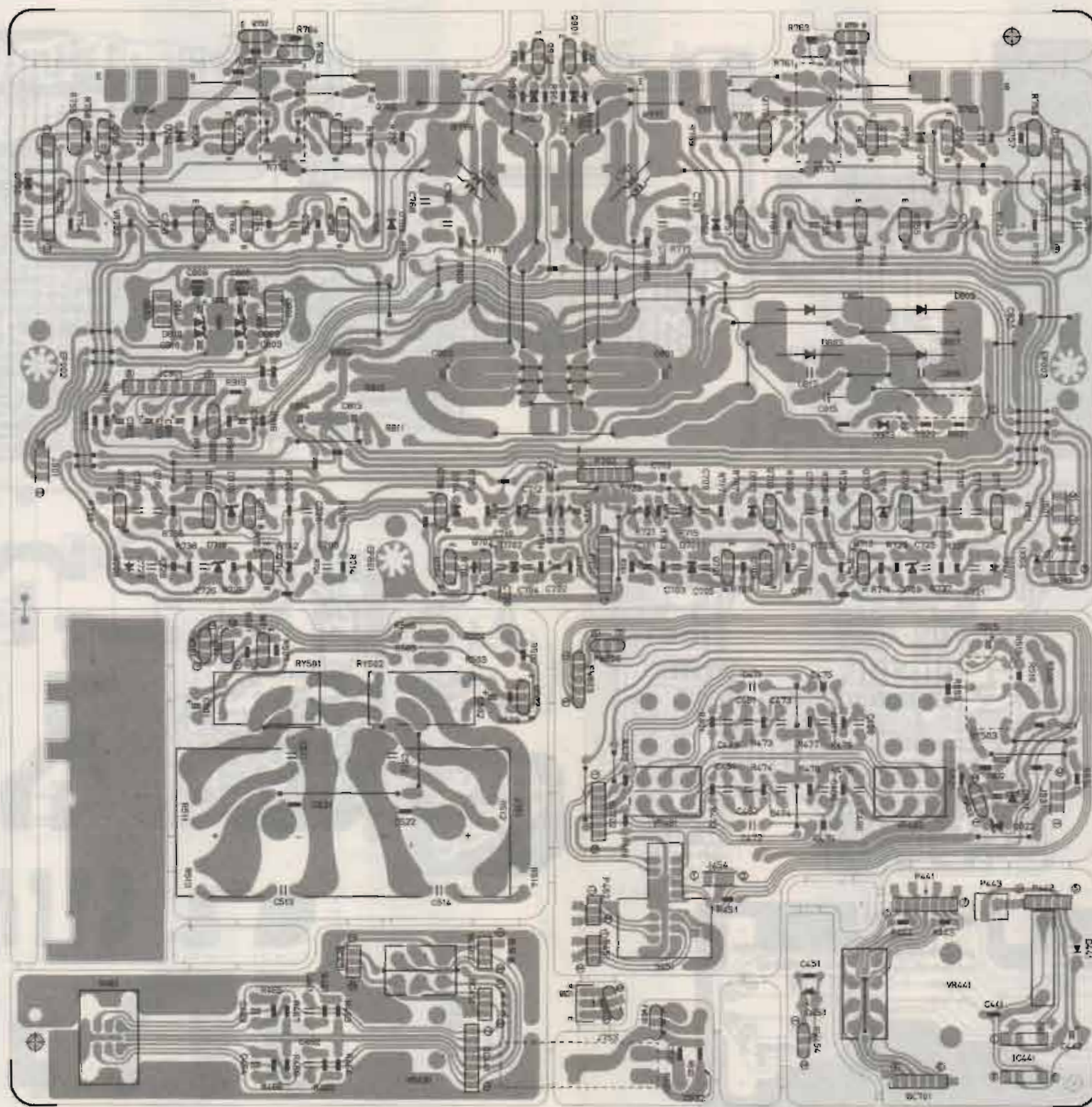

Schematic Diagrams

(1) Input & Front P.C. Board Section

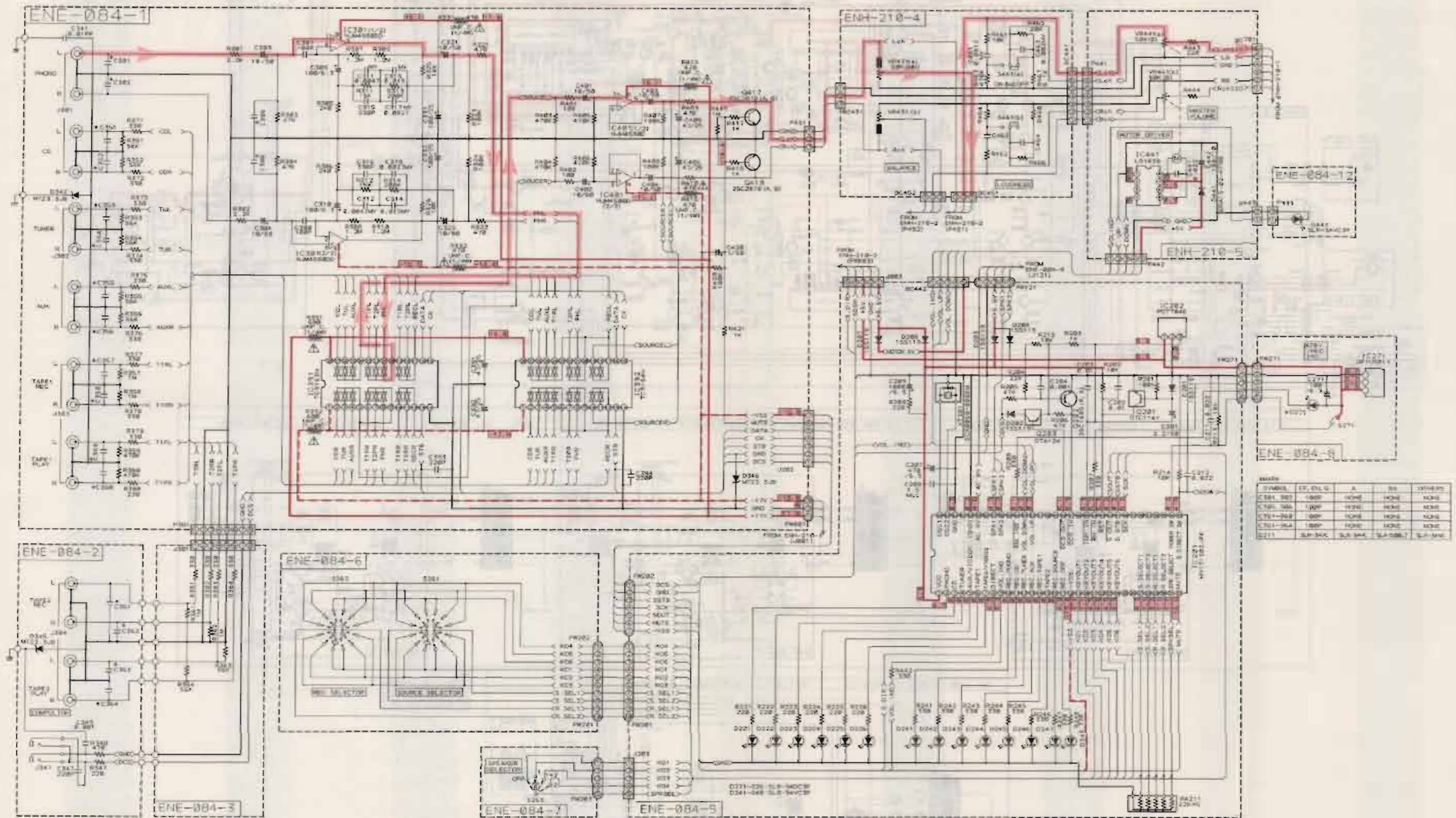

Notes:

1. — indicates + B power supply.
2. — indicates - B power supply.
3. indicates signal path.
4. show DC voltage to the chassis with no signal input.
(Source Direct mode)

5. When replacing the parts in the darkened are () and those marked with Δ , be sure to use the designated parts to ensure safety.
6. This is the standard circuit diagram.
The design and contents are subject to change without notice.

(2) Power Amplifier & Power Supply P.C. Board Section

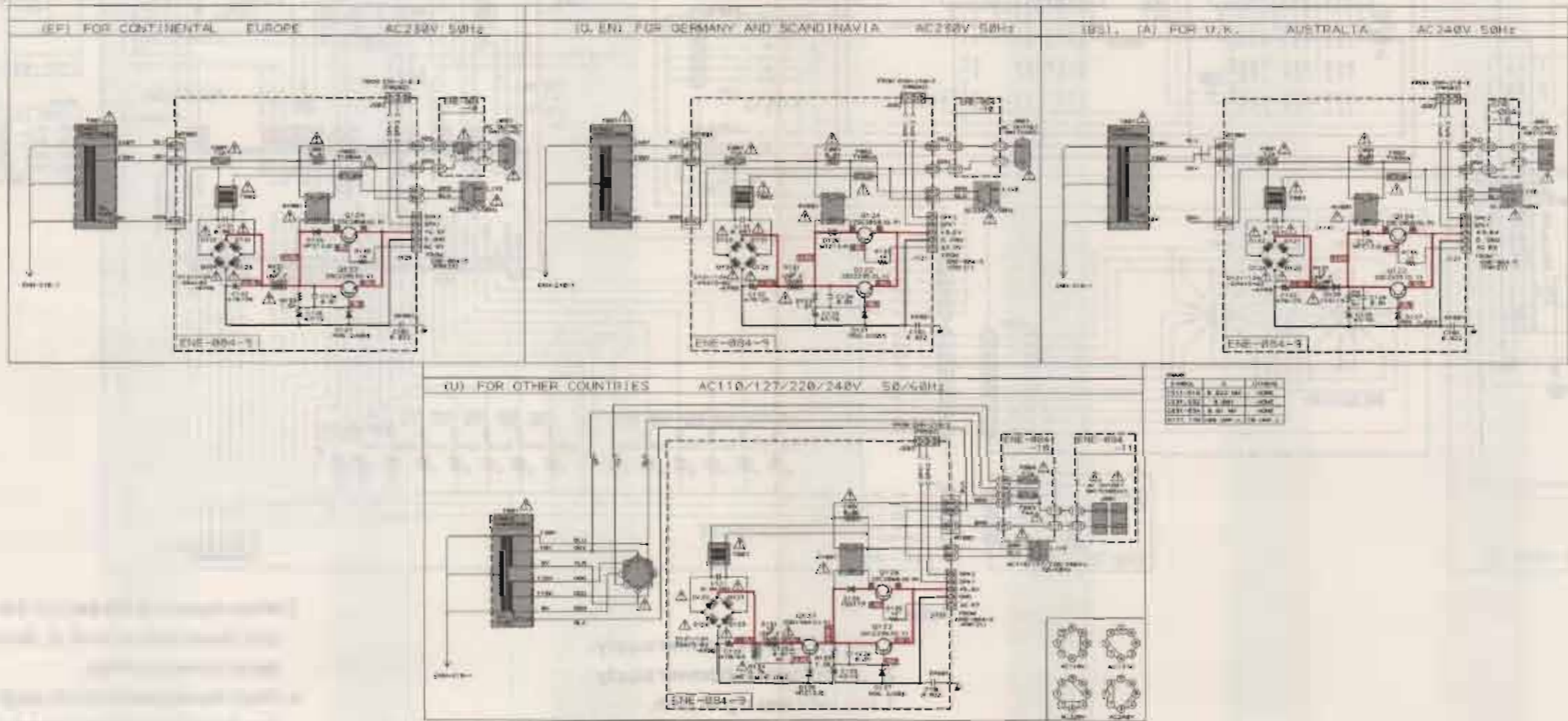
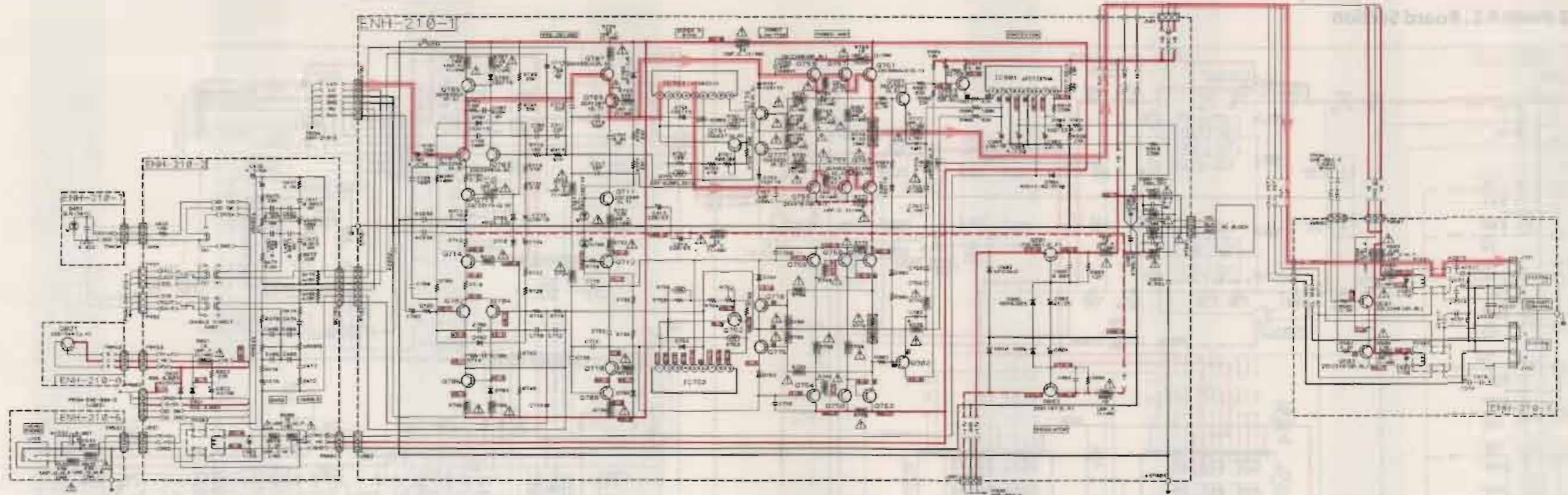

Part No.	Quantity	Notes
1000-010	1	OPTIONAL
1000-011	1	OPTIONAL
1000-012	1	OPTIONAL
1000-013	1	OPTIONAL
1000-014	1	OPTIONAL
1000-015	1	OPTIONAL
1000-016	1	OPTIONAL
1000-017	1	OPTIONAL
1000-018	1	OPTIONAL
1000-019	1	OPTIONAL
1000-020	1	OPTIONAL
1000-021	1	OPTIONAL
1000-022	1	OPTIONAL
1000-023	1	OPTIONAL
1000-024	1	OPTIONAL
1000-025	1	OPTIONAL
1000-026	1	OPTIONAL
1000-027	1	OPTIONAL
1000-028	1	OPTIONAL
1000-029	1	OPTIONAL
1000-030	1	OPTIONAL
1000-031	1	OPTIONAL
1000-032	1	OPTIONAL
1000-033	1	OPTIONAL
1000-034	1	OPTIONAL
1000-035	1	OPTIONAL
1000-036	1	OPTIONAL
1000-037	1	OPTIONAL
1000-038	1	OPTIONAL
1000-039	1	OPTIONAL
1000-040	1	OPTIONAL
1000-041	1	OPTIONAL
1000-042	1	OPTIONAL
1000-043	1	OPTIONAL
1000-044	1	OPTIONAL
1000-045	1	OPTIONAL
1000-046	1	OPTIONAL
1000-047	1	OPTIONAL
1000-048	1	OPTIONAL
1000-049	1	OPTIONAL
1000-050	1	OPTIONAL
1000-051	1	OPTIONAL
1000-052	1	OPTIONAL
1000-053	1	OPTIONAL
1000-054	1	OPTIONAL
1000-055	1	OPTIONAL
1000-056	1	OPTIONAL
1000-057	1	OPTIONAL
1000-058	1	OPTIONAL
1000-059	1	OPTIONAL
1000-060	1	OPTIONAL
1000-061	1	OPTIONAL
1000-062	1	OPTIONAL
1000-063	1	OPTIONAL
1000-064	1	OPTIONAL
1000-065	1	OPTIONAL
1000-066	1	OPTIONAL
1000-067	1	OPTIONAL
1000-068	1	OPTIONAL
1000-069	1	OPTIONAL
1000-070	1	OPTIONAL
1000-071	1	OPTIONAL
1000-072	1	OPTIONAL
1000-073	1	OPTIONAL
1000-074	1	OPTIONAL
1000-075	1	OPTIONAL
1000-076	1	OPTIONAL
1000-077	1	OPTIONAL
1000-078	1	OPTIONAL
1000-079	1	OPTIONAL
1000-080	1	OPTIONAL
1000-081	1	OPTIONAL
1000-082	1	OPTIONAL
1000-083	1	OPTIONAL
1000-084	1	OPTIONAL
1000-085	1	OPTIONAL
1000-086	1	OPTIONAL
1000-087	1	OPTIONAL
1000-088	1	OPTIONAL
1000-089	1	OPTIONAL
1000-090	1	OPTIONAL
1000-091	1	OPTIONAL
1000-092	1	OPTIONAL
1000-093	1	OPTIONAL
1000-094	1	OPTIONAL
1000-095	1	OPTIONAL
1000-096	1	OPTIONAL
1000-097	1	OPTIONAL
1000-098	1	OPTIONAL
1000-099	1	OPTIONAL
1000-100	1	OPTIONAL

- MEMO -

JVC

VICTOR COMPANY OF JAPAN, LIMITED
AUDIO DIVISION, YAMATO PLANT, 1644, SHIMOTSURUMA, YAMATO-SHI, KANAGAWA-KEN, 242, JAPAN